



MORE PEOPLE BUY AND
FLY CESSNA AIRPLANES
THAN ANY OTHER MAKE

1973

WORLD'S LARGEST PRO-
DUCER OF GENERAL
AVIATION AIRCRAFT
SINCE 1956

**MODEL
150**



**OWNER'S
MANUAL**

PERFORMANCE - SPECIFICATIONS

Model 150 *

GROSS WEIGHT	1600 lbs			
SPEED:				
Top Speed at Sea Level.	122 mph			
Cruise, 75% Power at 7000 ft.	117 mph			
RANGE:				
Cruise, 75% Power at 7000 ft.	475 mi			
22.5 Gallons, No Reserve	4.4 hrs			
	117 mph			
Cruise, 75% Power at 7000 ft.	725 mi			
35 Gallons, No Reserve	6.2 hrs			
	117 mph			
Optimum Range at 10,000 ft.	565 mi			
22.5 Gallons, No Reserve	6.1 hrs			
	93 mph			
Optimum Range at 10,000 ft.	880 mi			
35 Gallons, No Reserve	9.4 hrs			
	93 mph			
RATE OF CLIMB AT SEA LEVEL	670 fpm			
SERVICE CEILING	12,650 ft			
TAKE-OFF:				
Ground Run	735 ft			
Total Distance Over 50-Ft Obstacle	1385 ft			
LANDING:				
Ground Roll	445 ft			
Total Distance Over 50-Ft Obstacle	1075 ft			
STALL SPEEDS:				
Flaps Up, Power Off	55 mph			
Flaps Down, Power Off	48 mph			
BAGGAGE	120 lbs			
POWER LOADING: Pounds/HP	16.0			
FUEL CAPACITY: Total				
Standard Tanks	26 gal.			
Optional Long Range Tanks	38 gal.			
OIL CAPACITY: Total	6 qts			
PROPELLER: Fixed Pitch (Diameter).	69 inches			
ENGINE: Continental Engine	O-200-A			
100 rated HP at 2750 RPM				
	<u>Standard</u>	<u>Trainer</u>	<u>Commuter</u>	<u>F150</u>
EMPTY WEIGHT: (Approximate)	990 lbs	1010 lbs	1060 lbs	1020 lbs
USEFUL LOAD: (Approximate)	610 lbs	590 lbs	540 lbs	580 lbs
WING LOADING: Pounds/Sq Foot	10.2	10.2	10.0	10.0

* This manual covers operation of the Model 150 which is certificated as Model 150L under FAA Type Certificate No. 3A19. The manual also covers operation of the Model Reims/Cessna F150 which is certificated as Model F150L under French Type Certificate No. 38/3 and FAA Type Certificate No. A13EU. The Model F150, manufactured by Reims Aviation S.A., Reims (Marne), France, is identical to the 150 except that it is powered by an O-200-A engine manufactured under license by Rolls Royce, Crewe, England.

CONGRATULATIONS

Welcome to the ranks of Cessna owners! Your Cessna has been designed and constructed to give you the most in performance, economy, and comfort. It is our desire that you will find flying it, either for business or pleasure, a pleasant and profitable experience.

This Owner's Manual has been prepared as a guide to help you get the most pleasure and utility from your Model 150. It contains information about your Cessna's equipment, operating procedures, and performance; and suggestions for its servicing and care. We urge you to read it from cover to cover, and to refer to it frequently.

Our interest in your flying pleasure has not ceased with your purchase of a Cessna. World-wide, the Cessna Dealer Organization backed by the Cessna Service Department stands ready to serve you. The following services are offered by most Cessna Dealers:

THE CESSNA WARRANTY -- It is designed to provide you with the most comprehensive coverage possible:

- a. No exclusions
- b. Coverage includes parts and labor
- c. Available at Cessna Dealers world wide
- d. Best in the industry

Specific benefits and provisions of the warranty plus other important benefits for you are contained in your Customer Care Program book supplied with your aircraft. Warranty service is available to you at any authorized Cessna Dealer throughout the world upon presentation of your Customer Care Card which establishes your eligibility under the warranty.

FACTORY TRAINED PERSONNEL to provide you with courteous expert service.

FACTORY APPROVED SERVICE EQUIPMENT to provide you with the most efficient and accurate workmanship possible.

A STOCK OF GENUINE CESSNA SERVICE PARTS on hand when you need them.

THE LATEST AUTHORITATIVE INFORMATION FOR SERVICING CESSNA AIRPLANES, since Cessna Dealers have all of the Service Manuals and Parts Catalogs, kept current by Service Letters and Service News Letters, published by Cessna Aircraft Company.

We urge all Cessna owners to use the Cessna Dealer Organization to the fullest.

A current Cessna Dealer Directory accompanies your new airplane. The Directory is revised frequently, and a current copy can be obtained from your Cessna Dealer. Make your Directory one of your cross-country flight planning aids; a warm welcome awaits you at every Cessna Dealer.

* Maximum height of airplane with nose gear depressed, all tires and nose strut properly inflated, and optional flashing beacon installed.

** Maximum wing span if optional conical camber wing tips and optional strobe lights are installed. If standard wing tips without strobe lights are installed, wing span is 32'-8 1/2".

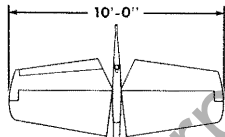
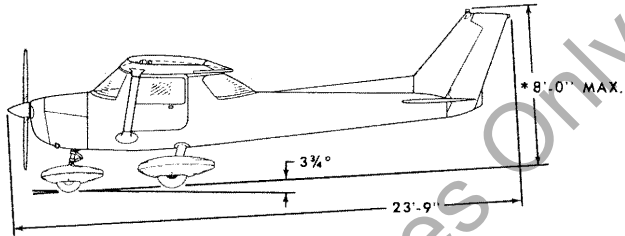

PRINCIPAL DIMENSIONS

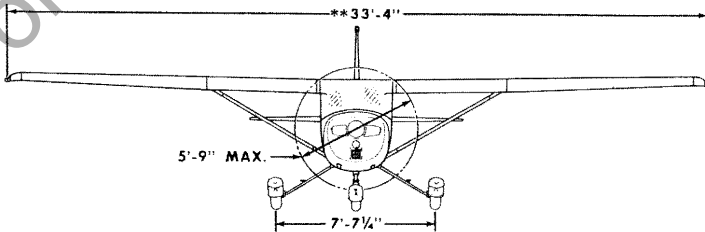
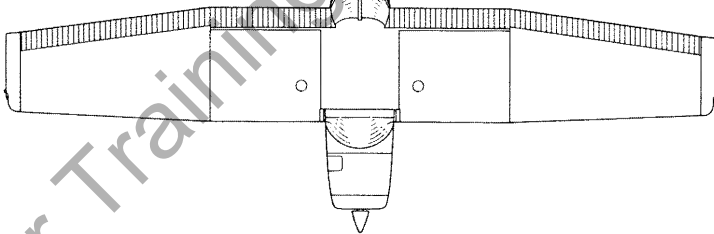

TABLE OF CONTENTS

	Page =
SECTION I - OPERATING CHECK LIST	1-1
SECTION II - DESCRIPTION AND OPERATING DETAILS	2-1
SECTION III - EMERGENCY PROCEDURES	3-1
SECTION IV - OPERATING LIMITATIONS	4-1
SECTION V - CARE OF THE AIRPLANE	5-1
OWNER FOLLOW-UP SYSTEM	5-11
SECTION VI - OPERATIONAL DATA	6-1
SECTION VII- OPTIONAL SYSTEMS	7-1

This manual describes the operation and performance of the Standard Model 150, the Trainer and the Commuter. Equipment described as "Optional" denotes that the subject equipment is optional on the Standard airplane. Much of this equipment is standard on the Trainer and Commuter.

For Training Purposes Only

Section I

OPERATING CHECK LIST

One of the first steps in obtaining the utmost performance, service, and flying enjoyment from your Cessna is to familiarize yourself with your airplane's equipment, systems, and controls. This can best be done by reviewing this equipment while sitting in the airplane. Those items whose function and operation are not obvious are covered in Section II.

Section I lists, in Pilot's Check List form, the steps necessary to operate your airplane efficiently and safely. It is not a check list in its true form as it is considerably longer, but it does cover briefly all of the points that you should know for a typical flight. An abbreviated check list covering the "Before Take-Off" and "Before Landing" phases of aircraft operation is provided on a plastic card and normally stowed in the map compartment. This abbreviated check list is a convenient reference of key items to be rechecked immediately prior to taxiing into position for take-off and before entering the final approach for landing.

The flight and operational characteristics of your airplane are normal in all respects. There are no unconventional characteristics or operations that need to be mastered. All controls respond in the normal way within the entire range of operation. All airspeeds mentioned in Sections I, II and III are indicated airspeeds. Corresponding calibrated airspeeds may be obtained from the Airspeed Correction Table in Section VI.

BEFORE ENTERING THE AIRPLANE.

- (1) Make an exterior inspection in accordance with figure 1-1.

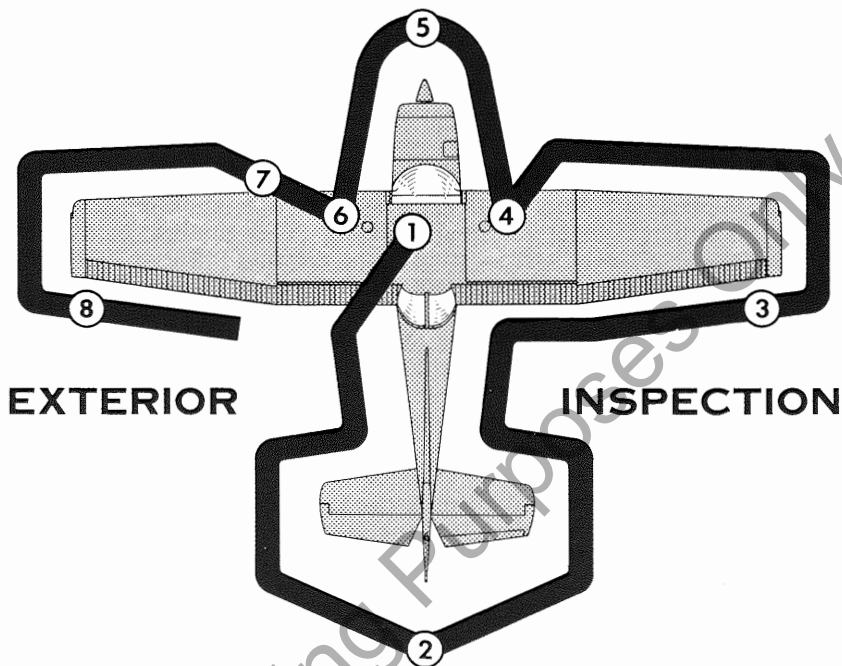

Note

Visually check aircraft for general condition during walk-around inspection. In cold weather, remove even small accumulations of frost, ice or snow from wing, tail and control surfaces. Also, make sure that control surfaces contain no internal accumulations of ice or debris. If night flight is planned, check operation of all lights, and make sure a flashlight is available.

- ① a. Remove control wheel lock.
- b. Check ignition switch "OFF."
- c. Turn on master switch and check fuel quantity indicators, then turn master switch "OFF."
- d. Check fuel shutoff valve handle "ON."

Figure

- ②
 - a. Remove rudder gust lock, if installed.
 - b. Disconnect tail tie-down.
 - c. Check control surfaces for freedom of movement and security.
- ③
 - a. Check aileron for freedom of movement and security.
- ④
 - a. Disconnect wing tie-down.
 - b. Check main wheel tire for proper inflation.
 - c. Visually check fuel quantity, then check fuel filler cap secure.
- ⑤
 - a. Check oil level. Do not operate with less than four quarts. Fill to six quarts for extended flight.
 - b. Before first flight of day and after each refueling, pull out strainer drain knob for about four seconds to clear fuel strainer of possible water and sediment. Check strainer drain closed. If water is observed, there is a possibility that the wing tank sumps contain water. Thus, the wing tank sump drain plugs and fuel line drain plug should be removed to check for presence of water.
 - c. Check propeller and spinner for nicks and security.
 - d. Check carburetor air filter for restrictions by dust or other foreign matter.
 - e. Check landing light for condition and cleanliness.
 - f. Check nose wheel strut and tire for proper inflation.
 - g. Disconnect nose tie-down.
 - h. Inspect flight instrument static source opening on left side of fuselage for stoppage.
- ⑥
 - a. Visually check fuel quantity, then check fuel filler cap secure.
 - b. Check main wheel tire for proper inflation.
- ⑦
 - a. Remove pitot tube cover, if installed, and check pitot tube opening for stoppage.
 - b. Check stall warning vent opening for stoppage.
 - c. Check fuel tank vent opening for stoppage.
 - d. Disconnect wing tie-down.
- ⑧
 - a. Check aileron for freedom of movement and security.

BEFORE STARTING THE ENGINE.

- (1) Seats, Seat Belts, and Shoulder Harnesses -- Adjust and lock.
- (2) Fuel Shutoff Valve Handle -- "ON."
- (3) Brakes -- Test and set.
- (4) Radios and Electrical Equipment -- "OFF."

STARTING THE ENGINE.

- (1) Carburetor Heat -- Cold.
- (2) Mixture -- Rich.
- (3) Primer -- As required.
- (4) Throttle -- Open 1/4 inch.
- (5) Master Switch -- "ON."
- (6) Propeller Area -- Clear.
- (7) Ignition Switch -- "START" (release when engine starts).
- (8) Oil Pressure -- Check.

BEFORE TAKE-OFF.

- (1) Cabin Doors -- Latched.
- (2) Flight Controls -- Check for free and correct movement.
- (3) Elevator Trim Control Wheel -- "TAKE-OFF" setting.
- (4) Throttle Setting -- 1700 RPM.
- (5) Engine Instruments -- Within green arc.
- (6) Suction Gage -- Check in green arc (4.6 to 5.4 inches of mercury).
- (7) Magnetos -- Check (RPM drop should not exceed 150 RPM on either magneto or 75 RPM differential between magnetos).
- (8) Carburetor Heat -- Check operation.
- (9) Flight Instruments and Radios -- Set.
- (10) Optional Wing Leveler -- "OFF,"

TAKE-OFF.

NORMAL TAKE-OFF.

- (1) Wing Flaps -- Up.
- (2) Carburetor Heat -- Cold.
- (3) Throttle - Full "OPEN."

- (4) Elevator Control -- Lift nose wheel at 55 MPH.
- (5) Climb Speed -- 70 to 80 MPH.

MAXIMUM PERFORMANCE TAKE-OFF.

- (1) Wing Flaps -- Up.
- (2) Carburetor Heat -- Cold.
- (3) Brakes -- Hold.
- (4) Throttle -- Full "OPEN."
- (5) Brakes -- Release.
- (6) Elevator Control -- Slightly tail low.
- (7) Climb Speed -- 70 MPH (with obstacles ahead).

CLIMB.

- (1) Airspeed -- 75 to 85 MPH.

NOTE

If a maximum performance climb is necessary, use speeds shown in the Maximum Rate-Of-Climb Data Chart in Section VI.

- (2) Throttle -- Full "OPEN."
- (3) Mixture -- Rich (unless engine is rough).

CRUISING.

- (1) Power -- 2000 to 2750 RPM.
- (2) Elevator Trim Control Wheel -- Adjust.
- (3) Mixture -- Lean to maximum RPM.

BEFORE LANDING.

- (1) Mixture -- Rich.
- (2) Carburetor Heat -- Apply full heat before closing throttle.
- (3) Airspeed -- 70 to 80 MPH (flaps up).
- (4) Wing Flaps -- As desired below 100 MPH.
- (5) Airspeed -- 60 to 70 MPH (flaps extended).

BALKED LANDING (GO-AROUND).

- (1) Throttle -- Full "OPEN."
- (2) Carburetor Heat -- Cold.
- (3) Wing Flaps -- Retract to 20°.
- (4) Upon reaching an airspeed of approximately 65 MPH, retract flaps slowly.

NORMAL LANDING.

- (1) Touchdown -- Main wheels first.
- (2) Landing Roll -- Lower nose wheel gently.
- (3) Braking -- Minimum required.

AFTER LANDING.

- (1) Wing Flaps -- Up.
- (2) Carburetor Heat -- Cold.

SECURING AIRCRAFT.

- (1) Parking Brake -- Set.
- (2) Radios and Electrical Equipment -- "OFF."
- (3) Mixture -- Idle cut-off (pulled full out).
- (4) Ignition and Master Switches - "OFF."
- (5) Control Lock -- Installed.

For Training Purposes Only

INSTRUMENT PANEL

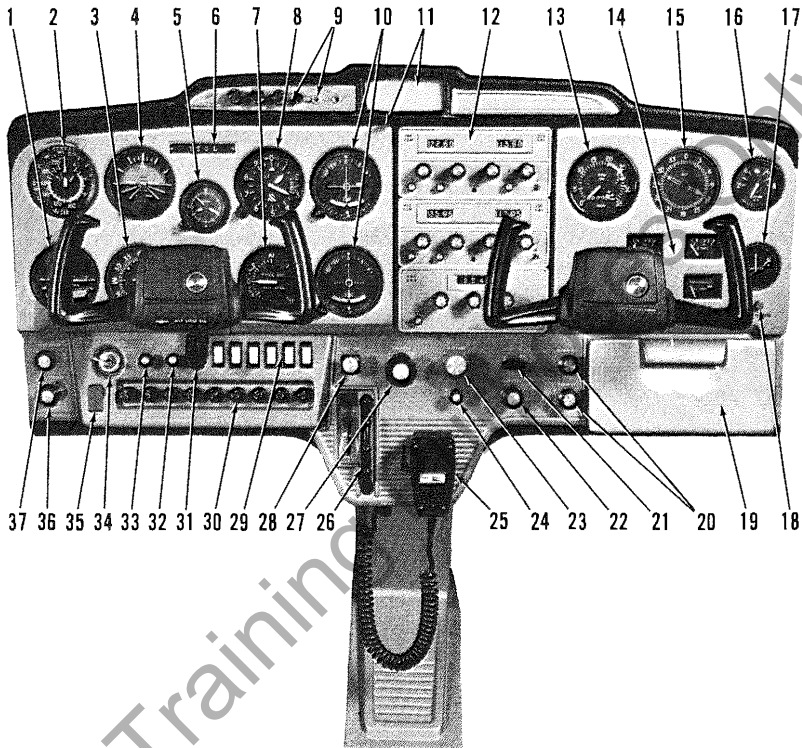

- | | | |
|---|--|--|
| <ol style="list-style-type: none"> 1. Turn Coordinator (Opt.) 2. Airspeed Indicator 3. Directional Gyro (Opt.) 4. Gyro Horizon (Opt.) 5. Clock (Opt.) 6. Aircraft Registration Number 7. Vertical Speed Indicator (Opt.) 8. Altimeter 9. Marker Beacon Indicator 10. Omni Course Indicators (Opt.) 11. Rear View Mirror and Control (Opt.) | <ol style="list-style-type: none"> 12. Radios (Opt.) 13. Tachometer 14. Fuel and Oil Gages 15. ADF Bearing Indicator (Opt.) 16. Suction Gage (Opt.) 17. Ammeter 18. Over-Voltage Warning Light 19. Map Compartment 20. Cabin Air/Heat Control Knobs 21. Wing Flap Switch 22. Cigar Lighter (Opt.) 23. Mixture Control Knob 24. Wing Leveler Control Knob (Opt.) | <ol style="list-style-type: none"> 25. Microphone (Opt.) 26. Elevator Trim Control Wheel 27. Throttle 28. Carburetor Heat Control Knob 29. Electrical Switches 30. Fuses 31. Alternator Circuit Breaker 32. Radio Dial Light Rheostat 33. Panel Lights Rheostat 34. Ignition/Starter Switch 35. Master Switch 36. Primer 37. Parking Brake Knob |
|---|--|--|

Figure 2-1.

Section II

DESCRIPTION AND OPERATING DETAILS

The following paragraphs describe the systems and equipment whose function and operation is not obvious when sitting in the airplane. This section also covers in somewhat greater detail some of the items listed in Check List form in Section I that require further explanation.

FUEL SYSTEM.

Fuel is supplied to the engine from two tanks, one in each wing. From these tanks, fuel flows by gravity through a fuel shutoff valve and fuel strainer to the carburetor.

Refer to figure 2-2 for fuel quantity data. For fuel system service information, refer to Lubrication and Servicing Procedures in Section V.

FUEL STRAINER DRAIN KNOB.

Refer to fuel strainer servicing procedure, Section V.

FUEL QUANTITY DATA (U.S. GALLONS)

TANKS	USABLE FUEL ALL FLIGHT CONDITIONS	UNUSABLE FUEL	TOTAL FUEL VOLUME
TWO, STANDARD WING (13 GAL. EACH)	22.5	3.5	26.0
TWO, LONG RANGE WING (19 GAL. EACH)	35.0	3.0	38.0

Figure 2-2.

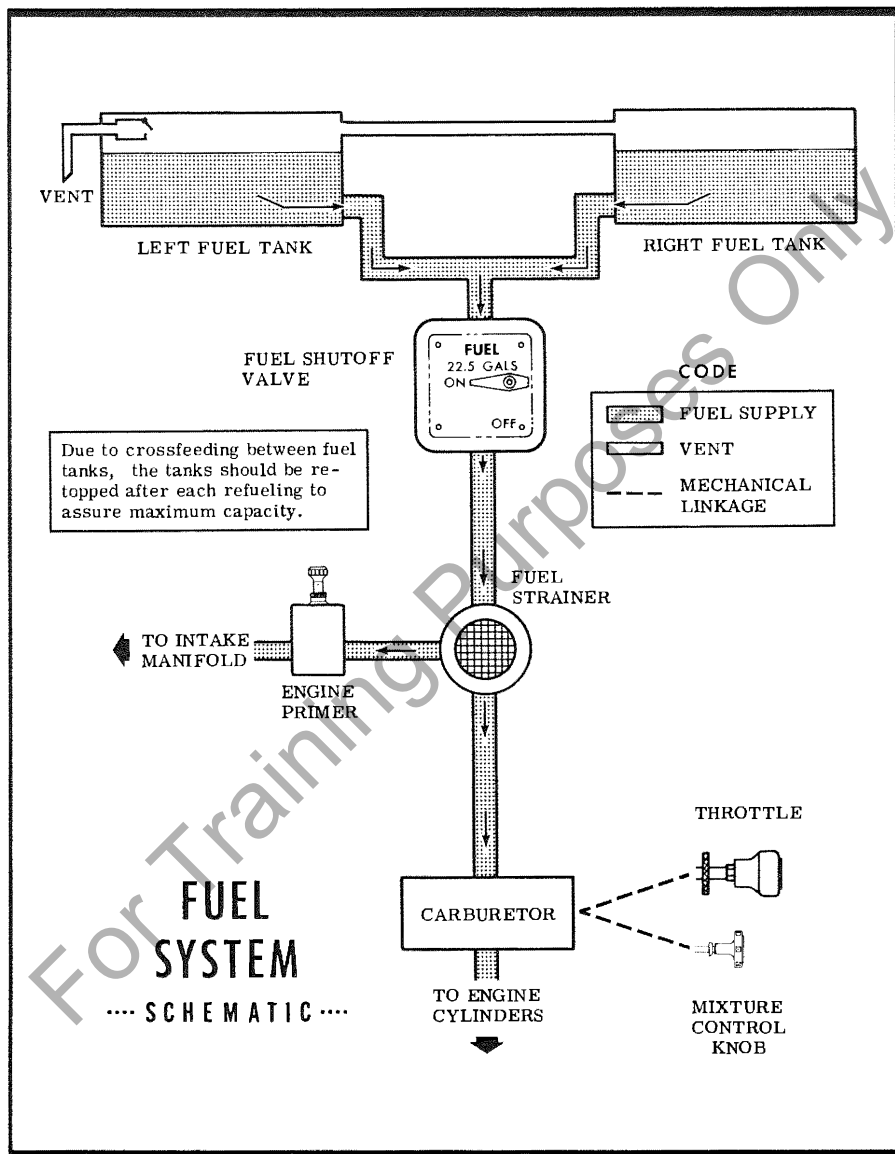

Figure 2-3.

ELECTRICAL SYSTEM.

Electrical energy is supplied by a 14-volt, direct-current system powered by an engine-driven alternator (see figure 2-4). A 12-volt battery is located on the right, forward side of the firewall just inside the cowl access door. Power is supplied through a single bus bar; a master switch controls this power to all circuits, except the engine ignition system, optional clock and optional flight hour recorder (operative only when the engine is operating).

MASTER SWITCH.

The master switch is a split-rocker type switch labeled "MASTER," and is "ON" in the up position and "OFF" in the down position. The right half of the switch, labeled "BAT," controls all electrical power to the airplane. The left half, labeled "ALT," controls the alternator.

Normally, both sides of the master switch should be used simultaneously; however, the "BAT" side of the switch could be turned "ON" separately to check equipment while on the ground. The "ALT" side of the switch, when placed in the "OFF" position, removes the alternator from the electrical system. With this switch in the "OFF" position, the entire electrical load is placed on the battery. Continued operation with the alternator switch "OFF" will reduce battery power low enough to open the battery contactor, remove power from the alternator field, and prevent alternator restart.

AMMETER.

The ammeter indicates the flow of current, in amperes, from the alternator to the battery or from the battery to the aircraft electrical system. When the engine is operating and the master switch is "ON," the ammeter indicates the charging rate applied to the battery. In the event the alternator is not functioning or the electrical load exceeds the output of the alternator, the ammeter indicates the discharge rate of the battery.

OVER-VOLTAGE SENSOR AND WARNING LIGHT.

The aircraft is equipped with an automatic over-voltage protection system consisting of an over-voltage sensor behind the instrument panel and a red warning light, labeled "HIGH VOLTAGE", near the ammeter.

In the event an over-voltage condition occurs, the over-voltage sensor automatically removes alternator field current and shuts down the

ELECTRICAL SYSTEM SCHEMATIC

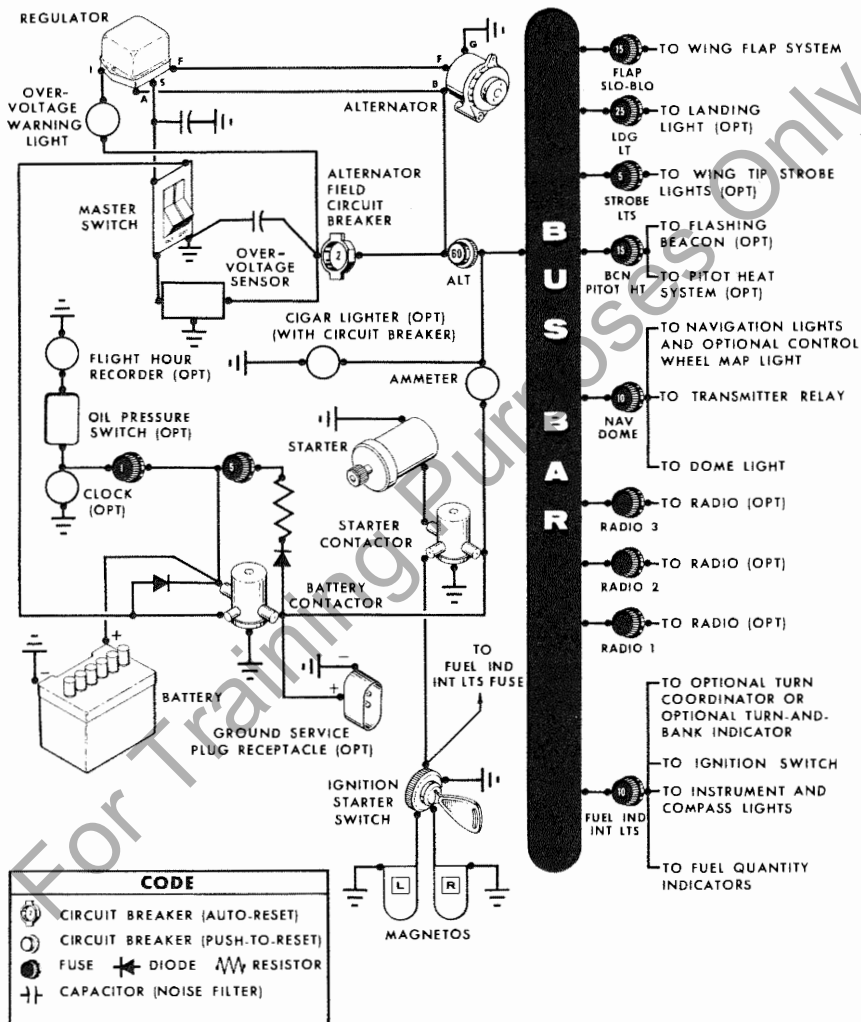

Figure 2-4.

alternator. The red warning light will then turn on, indicating to the pilot that the alternator is not operating and the aircraft battery is supplying all electrical power.

The over-voltage sensor may be reset by turning the master switch off and back on again. If the warning light does not illuminate, normal alternator charging has resumed; however, if the light does illuminate again, a malfunction has occurred, and the flight should be terminated as soon as practical.

The over-voltage warning light may be tested by momentarily turning off the "ALT" portion of the master switch and leaving the "BAT" portion turned on.

FUSES AND CIRCUIT BREAKERS.

Fuses on the left lower portion of the instrument panel protect the majority of electrical circuits in the airplane. Labeling below each fuse retainer indicates the circuits protected by the fuses. Fuse capacity is shown on each fuse retainer cap. Fuses are removed by pressing the fuse retainers inward and rotating them counterclockwise until they disengage. The faulty fuse may then be lifted out and replaced. Spare fuses are held in a clip inside the map compartment.

NOTE

A special "SLO-BLO" fuse protects the wing flaps circuit. If this fuse is replaced, care should be taken to assure that the replacement fuse is of the proper type and capacity. A "SLO-BLO" fuse is identified by an integrally mounted spring encircling the fuse element.

Two additional fuses are located adjacent to the battery; one fuse protects the battery contactor closing circuit, and the other fuse protects the optional clock and optional flight hour recorder circuits.

The airplane utilizes three circuit breakers for circuit protection. A "push-to-reset" circuit breaker (labeled "ALT") is located on the left side of the instrument panel near the fuses and protects the alternator circuit. The alternator field and wiring is protected by an automatically resetting circuit breaker mounted behind the left side of the instrument panel. The cigar lighter has a manually reset type circuit breaker mounted directly on the back of the lighter behind the instrument panel.

When more than one radio is installed, the radio transmitter relay

(which is a part of the radio installation) is protected by the fuse labeled "NAV-DOME." It is important to remember that any malfunction in other systems protected by this fuse (navigation lights, dome light, or optional control wheel map light) which causes the fuse to open will de-activate these systems and the transmitter relay. In this event, the switches for these lighting systems should be turned off to isolate the circuits; then replace the "NAV-DOME" fuse to re-activate the transmitter relay and permit its usage. Do not turn on any of the lights protected by the fuse until the malfunction has been corrected.

LIGHTING EQUIPMENT.

EXTERIOR LIGHTING.

Conventional navigation lights are located on the wing tips and top of the rudder. Optional lighting includes a single landing light in the cowl nose cap, a flashing beacon on the top of the vertical fin, and a strobe light on each wing tip. All exterior lights are controlled by rocker type switches on the left switch and control panel. The switches are "ON" in the up position and "OFF" in the down position.

The flashing beacon should not be used when flying through clouds or overcast; the flashing light reflected from water droplets or particles in the atmosphere, particularly at night, can produce vertigo and loss of orientation.

The two high intensity strobe lights will enhance anti-collision protection. However, the lights should be turned off when taxiing in the vicinity of other aircraft, or during flight through clouds, fog or haze.

INTERIOR LIGHTING.

Illumination of the instrument panel is provided by red flood lighting in the forward portion of the overhead console. The magnetic compass is illuminated by integral lighting. A dimming rheostat on the left switch and control panel operates these lights. A second rheostat on the panel controls optional radio lighting. Lighting intensity is decreased as the rheostats are turned counterclockwise.

An optional map light may be mounted on the bottom of the pilot's control wheel. The light illuminates the lower portion of the cabin just forward of the pilot and is helpful when checking maps and other flight data during night operations. To operate the light, first turn on the

NAV LT switch, then adjust the map light's intensity with the rheostat disc located at the bottom of the control wheel.

A cabin dome light in the overhead console is controlled by a rocker type switch on the left switch and control panel. The switch is "ON" in the up position and "OFF" in the down position.

WING FLAP SYSTEM.

The wing flaps are electrically operated by a flap motor located in the right wing. Flap position is controlled by a switch, labeled "WING FLAPS", on the lower center portion of the instrument panel. Flap position is mechanically indicated by a pointer housed in the left front door-post.

To extend the wing flaps, the flap switch must be depressed and held in the "DOWN" position until the desired degree of extension is reached. Releasing the switch allows it to return to the center off position. Normal full flap extension in flight will require approximately 9 seconds. After the flaps reach maximum extension or retraction, limit switches will automatically shut off the flap motor.

To retract the flaps, place the flap switch in the "UP" position. The switch will remain in the "UP" position without manual assistance due to an over-center design of the switch. Full flap retraction in flight requires approximately 6 seconds. More gradual flap retraction can be accomplished by intermittent operation of the flap switch to the "UP" position. After full retraction, the switch is normally returned to the center off position.

CABIN HEATING AND VENTILATING SYSTEM.

The temperature and volume of airflow into the cabin can be regulated to any degree desired by manipulation of the push-pull "CABIN HT" and "CABIN AIR" knobs.

Heated fresh air and outside air are blended in a cabin manifold just aft of the firewall by adjustment of the heat and air controls; this air is then vented into the cabin from outlets in the cabin manifold near the

pilot's and passenger's feet. Windshield defrost air is also supplied by a duct leading from the manifold.

A separate adjustable ventilator near each upper corner of the windshield supplies additional outside air to the pilot and passenger.

PARKING BRAKE SYSTEM.

To set the parking brake, pull out on the parking brake knob, apply and release toe pressure to the pedals, and then release the parking brake knob. To release the parking brake, apply and release toe pressure on the pedals while checking to see that the parking brake knob is full in.

SEATS.

Standard seating consists of individually adjustable pilot and front passenger seats with two-position reclining backs. By raising a lever at the front of the seat on the inboard side, the seat can be adjusted fore and aft. A control knob near the center of the front edge of the seat is used to adjust the reclining angle of the seat back. To recline the back, pull the knob forward firmly and lean back against the seat. The control will remain extended as long as the seat back is reclined. To return the back of the seat to the upright position, pull forward on the bottom edge of the back. The back of these seats will also fold forward and lay down flat as an aid to stowing or retrieving articles from the baggage area.

A child's seat is available for installation in the rear of the cabin. The seat back is secured to the cabin sidewalls, and the seat bottom is attached to brackets on the floors. The child's seat is not adjustable.

SHOULDER HARNESES.

Shoulder harnesses are provided for the pilot and front seat passenger. Each harness is attached to the rear doorpost just above window

line and is stowed behind the cabin door. When stowed, each harness is held in place by two retaining clips on the rear doorpost. When stowing the harness, place it behind both retaining clips.

To use the shoulder harness, fasten and adjust the seat belt first. Remove the harness from the stowed position, and lengthen as required by pulling on the end of the harness and the narrow release strap. Snap the harness metal stud firmly into the retaining slot adjacent to the seat belt buckle. Then adjust to length by pulling down on the free end of the harness. A properly adjusted harness will permit the occupant to lean forward enough to sit completely erect but is tight enough to prevent excessive forward movement and contact with objects during sudden deceleration. Also, the pilot will want the freedom to reach all controls easily.

Releasing and removing the shoulder harness is accomplished by pulling upward on the narrow release strap and removing the harness stud from the slot in the seat belt buckle. In an emergency, the shoulder harness may be removed by releasing the seat belt first, and then pulling the harness over the head by pulling up on the release strap.

STARTING ENGINE.

Ordinarily the engine starts easily with one or two strokes of primer in warm temperatures to six strokes in cold weather, with the throttle open approximately 1/4 inch. In extremely cold temperatures, it may be necessary to continue priming while cranking.

Weak intermittent firing followed by puffs of black smoke from the exhaust stack indicates overpriming or flooding. Excess fuel can be cleared from the combustion chambers by the following procedure: Set the mixture control in full lean position, throttle full open, and crank the engine through several revolutions with the starter. Repeat the starting procedure without any additional priming.

If the engine is underprimed (most likely in cold weather with a cold engine) it will not fire at all, and additional priming will be necessary. As soon as the cylinders begin to fire, open the throttle slightly to keep it running.

After starting, if the oil gage does not begin to show pressure within 30 seconds in the summertime and about twice that long in very cold weather, stop engine and investigate. Lack of oil pressure can cause serious engine damage. After starting, avoid the use of carburetor heat unless icing conditions prevail.

TAXIING.

When taxiing, it is important that speed and use of brakes be held to a minimum and that all controls be utilized (see Taxiing Diagram, figure 2-5) to maintain directional control and balance.

Taxiing over loose gravel or cinders should be done at low engine speed to avoid abrasion and stone damage to the propeller tips.

The nose wheel is designed to automatically center straight ahead when the nose strut is fully extended. In the event the nose strut is over-inflated and the airplane is loaded to a rearward center of gravity position, it may be necessary to partially compress the strut to permit steering. This can be accomplished prior to taxiing by depressing the airplane nose (by hand) or during taxi by sharply applying brakes.

BEFORE TAKE-OFF.

WARM-UP.

Most of the warm-up will have been conducted during taxi, and additional warm-up before take-off should be restricted to the checks outlined in Section I. Since the engine is closely cowled for efficient in-flight cooling, precautions should be taken to avoid overheating on the ground.

MAGNETO CHECK.

The magneto check should be made at 1700 RPM as follows. Move ignition switch first to "R" position and note RPM. Next move switch back to "BOTH" to clear the other set of plugs. Then move switch to the "L" position, note RPM and return the switch to the "BOTH" position. RPM drop should not exceed 150 RPM on either magneto or show greater than 75 RPM differential between magnetos. If there is a doubt concerning operation of the ignition system, RPM checks at higher engine speeds will usually confirm whether a deficiency exists.

TAXIING DIAGRAM

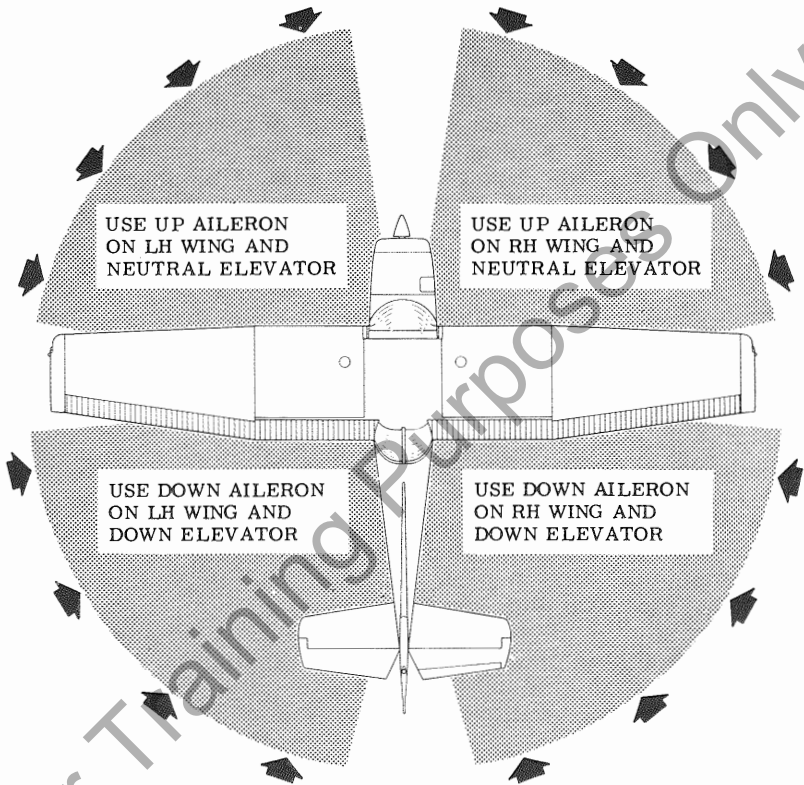

CODE

WIND DIRECTION

NOTE

Strong quartering tail winds require caution. Avoid sudden bursts of the throttle and sharp braking when the airplane is in this attitude. Use the steerable nose wheel and rudder to maintain direction.

Figure 2-5.

An absence of RPM drop may be an indication of faulty grounding of one side of the ignition system or should be cause for suspicion that the magneto timing is set in advance of the setting specified.

ALTERNATOR CHECK.

Prior to flights where verification of proper alternator and voltage regulator operation is essential (such as night or instrument flights), a positive verification can be made by loading the electrical system momentarily (3 to 5 seconds) with the optional landing light, (if so equipped), or by operating the wing flaps during the engine runup (1700 RPM). The ammeter will remain within a needle width of zero if the alternator and voltage regulator are operating properly.

TAKE-OFF.

POWER CHECKS.

It is important to check full-throttle engine operation early in the take-off run. Any signs of rough engine operation or sluggish engine acceleration is good cause for discontinuing the take-off. If this occurs, you are justified in making a thorough full-throttle, static runup before another take-off is attempted. The engine should run smoothly and turn approximately 2500 to 2600 RPM with carburetor heat off.

Full throttle runups over loose gravel are especially harmful to propeller tips. When take-offs must be made over a gravel surface, it is very important that the throttle be advanced slowly. This allows the airplane to start rolling before high RPM is developed, and the gravel will be blown back of the propeller rather than pulled into it. When unavoidable small dents appear in the propeller blades, they should be immediately corrected as described in Section V.

Prior to take-off from fields above 5000 feet elevation, the mixture should be leaned to give maximum RPM in a full-throttle, static runup.

FLAP SETTINGS.

Normal and obstacle clearance take-offs are performed with flaps up. The use of 10° flaps will shorten the ground run approximately 10%, but this advantage is lost in the climb to a 50-foot obstacle. Therefore the

use of 10° flaps is reserved for minimum ground runs or for take-off from soft or rough fields with no obstacles ahead.

If 10° of flaps are used in ground runs, it is preferable to leave them extended rather than retract them in the climb to the obstacle. The exception to this rule would be in a high altitude take-off in hot weather where climb would be marginal with flaps 10°. Flap deflections greater than 10° are not recommended at any time for take-off.

PERFORMANCE CHARTS.

Consult the Take-Off Distance chart in Section VI for take-off distances at gross weight under various altitude and headwind conditions.

CROSSWIND TAKE-OFFS.

Take-offs into strong crosswinds normally are performed with the minimum flap setting necessary for the field length, to minimize the drift angle immediately after take-off. The airplane is accelerated to a speed slightly higher than normal, then pulled off abruptly to prevent possible settling back to the runway while drifting. When clear of the ground, make a coordinated turn into the wind to correct for drift.

ENROUTE CLIMB.

CLIMB DATA.

For detailed data, see Maximum Rate-Of-Climb Data chart in Section VI.

CLIMB SPEEDS.

Normal climbs are conducted at 75 to 85 MPH with flaps up and full throttle, for best engine cooling. The mixture should be full rich unless the engine is rough due to too rich a mixture. The best rate-of-climb speeds range from 76 MPH at sea level to 70 MPH at 10,000 feet. If an obstruction dictates the use of a steep climb angle, climb at an obstacle clearance speed of 70 MPH with flaps retracted.

NOTE

Steep climbs at low speeds should be of short duration to allow improved engine cooling.

MAXIMUM CRUISE SPEED PERFORMANCE

75% POWER

ALTITUDE	RPM	TRUE AIRSPEED
Sea Level	2525	110
5000 Feet	2650	115
7000 Feet	Full Throttle	117

CRUISE.

Normal cruising is done between 65% and 75% power. The power settings required to obtain these powers at various altitudes and outside air temperatures can be determined by using your Cessna Power Computer or the OPERATIONAL DATA, Section VI.

Cruising can be done most efficiently at high altitude because of lower air density and therefore higher true airspeeds for the same power. This is illustrated in the table above which shows performance at 75% power at various altitudes.

To achieve the lean mixture fuel consumption figures shown in Section VI, the mixture should be leaned as follows: pull the mixture control out until engine RPM peaks and begins to fall off, then enrichen slightly back to peak RPM.

Carburetor ice, as evidenced by an unexplained drop in RPM, can be removed by application of full carburetor heat. Upon regaining the original RPM (with heat off), use the minimum amount of heat (by trial and error) to prevent ice from forming. Since the heated air causes a richer mixture, readjust the mixture setting when carburetor heat is to be used continuously in cruise flight.

The use of full carburetor heat is recommended during flight in very heavy rain to avoid the possibility of engine stoppage due to excessive water ingestion. The mixture setting should be readjusted for smoothest operation.

STALLS.

The stall characteristics are conventional for the flaps up and flaps

down condition. Slight elevator buffeting may occur just before the stall with flaps down.

Stall speeds are shown in Section VI for aft c. g., full gross weight conditions. They are presented as calibrated airspeeds because indicated airspeeds are unreliable near the stall. The stall warning horn produces a steady signal 5 to 10 MPH before the actual stall is reached and remains on until the airplane flight attitude is changed.

SPINS.

Spins are approved in this airplane (see Section IV). For recovery from an inadvertent or intentional spin, the following procedure should be used.

- (1) Retard throttle to idle position.
- (2) Apply full rudder opposite to the direction of rotation.
- (3) After one-fourth turn, move the control wheel forward of neutral in a brisk motion.
- (4) As rotation stops, neutralize rudder, and make a smooth recovery from the resulting dive.

Application of aileron in the direction of the spin will greatly increase the rotation rate and delay the recovery. Ailerons should be held in a neutral position throughout the spin and the recovery. Intentional spins with flaps extended are prohibited.

LANDING.

Normal landing approaches can be made with power-on or power-off at speeds of 70 to 80 MPH with flaps up, and 60 to 70 MPH with flaps down. Surface winds and air turbulence are usually the primary factors in determining the most comfortable approach speeds.

Actual touchdown should be made with power-off and on the main wheels first. The nose wheel should be lowered smoothly to the runway as speed is diminished.

SHORT FIELD LANDINGS.

For a maximum performance short field landing in smooth air conditions, make an approach at 60 MPH with 40° flaps using enough power to control the glide path. After all approach obstacles are cleared, progressively reduce power and maintain 60 MPH by lowering the nose of the airplane. Touchdown should be made with power-off and on the main wheels first. Immediately after touchdown, lower the nose wheel and apply heavy braking as required. For maximum brake effectiveness, retract the flaps, hold full nose-up elevator, and apply maximum brake pressure without sliding the tires.

Slightly higher approach speeds should be used under turbulent air conditions.

CROSSWIND LANDINGS.

When landing in a strong crosswind, use the minimum flap setting required for the field length. Use a wing low, crab, or a combination method of drift correction and land in a nearly level attitude.

Excessive nose strut inflation can hinder nose wheel alignment with the airplane ground track in a drifting crosswind landing at touchdown and during ground roll. This can be counteracted by firmly lowering the nose wheel to the ground after initial contact. This action partially compresses the nose strut, permitting nose wheel swiveling and positive ground steering.

BALKED LANDING (GO-AROUND).

In a balked landing (go-around) climb, the wing flap setting should be reduced to 20° immediately after full power is applied. Upon reaching a safe airspeed, the flaps should be slowly retracted to the full up position.

In critical situations where undivided attention to the airplane is required, the 20° flap setting can be approximated by holding the flap switch for approximately two seconds. This technique will allow the pilot to obtain the 20° setting without having to divert his attention to the flap position indicator.

COLD WEATHER OPERATION.

Prior to starting on cold mornings, it is advisable to pull the propeller through several times by hand to "break loose" or "limber" the oil, thus conserving battery energy.

NOTE

When pulling the propeller through by hand, treat it as if the ignition switch is turned on. A loose or broken ground wire on either magneto could cause the engine to fire.

In extremely cold (0° F and lower) weather, the use of an external pre-heater is recommended whenever possible to reduce wear and abuse to the engine and electrical system.

Cold weather starting procedures are as follows:

With Preheat:

- (1) With ignition switch "OFF" and throttle closed, prime the engine four to ten strokes as the propeller is being turned over by hand.

NOTE

Use heavy strokes of primer for best atomization of fuel. After priming, push primer all the way in and turn to locked position to avoid possibility of engine drawing fuel through the primer.

- (2) Propeller Area -- Clear.
- (3) Master Switch -- "ON."
- (4) Throttle -- Open 1/4".
- (5) Mixture -- Full rich.
- (6) Ignition Switch -- START.
- (7) Release ignition switch to BOTH when engine starts.
- (8) Oil Pressure -- Check.

Without Preheat:

- (1) Prime the engine eight to ten strokes while the propeller is being turned by hand with throttle closed. Leave primer charged and ready for stroke.
- (2) Propeller Area -- Clear.

- (3) Mixture -- Full rich.
- (4) Master Switch -- ON.
- (5) Ignition Switch -- START.
- (6) Pump throttle rapidly to full open twice. Return to 1/4" open position.
- (7) Release ignition switch to "BOTH" when engine starts.
- (8) Continue to prime engine until it is running smoothly, or alternately, pump throttle rapidly over first 1/4 of total travel.
- (9) Oil Pressure -- Check.
- (10) Pull carburetor heat knob full on after engine has started. Leave on until engine is running smoothly.
- (11) Lock primer.

NOTE

If the engine does not start during the first few attempts, or if engine firing diminishes in strength, it is probable that the spark plugs have been frosted over. Preheat must be used before another start is attempted.

IMPORTANT

Pumping the throttle may cause raw fuel to accumulate in the intake air duct, creating a fire hazard in the event of a backfire. If this occurs, maintain a cranking action to suck flames into the engine. An outside attendant with a fire extinguisher is advised for cold starts without pre-heat.

During cold weather operations, no indication will be apparent on the oil temperature gage prior to take-off if outside air temperatures are very cold. After a suitable warm-up period (2 to 5 minutes at 1000 RPM), accelerate the engine several times to higher engine RPM. If the engine accelerates smoothly and the oil pressure remains normal and steady, the airplane is ready for take-off.

When operating in sub-zero temperature, avoid using partial carburetor heat. Partial heat may increase the carburetor air temperature to the 32° to 70° range, where icing is critical under certain atmospheric conditions.

Refer to Section VII for cold weather equipment.

Section III

EMERGENCY PROCEDURES

Emergencies caused by aircraft or engine malfunctions are extremely rare if proper pre-flight inspections and maintenance are practiced. Enroute weather emergencies can be minimized or eliminated by careful flight planning and good judgement when unexpected weather is encountered. However, should an emergency arise the basic guidelines described in this section should be considered and applied as necessary to correct the problem.

ELECTRICAL POWER SUPPLY SYSTEM MALFUNCTIONS.

Malfunctions in the electrical power supply system can be detected by periodic monitoring of the ammeter and over-voltage warning light; however, the cause of these malfunctions is usually difficult to determine. Broken or loose alternator wiring is most likely the cause of alternator failures, although other factors could cause the problem. A damaged or improperly adjusted voltage regulator can also cause malfunctions. Problems of this nature constitute an electrical emergency and should be dealt with immediately. Electrical power malfunctions usually fall into two categories, excessive rate of charge and insufficient rate of charge. The paragraphs below describe the recommended remedy for each situation.

EXCESSIVE RATE OF CHARGE.

After engine starting and heavy electrical usage at low engine speeds (such as extended taxiing) the battery condition will be low enough to accept above normal charging during the initial part of a flight. However, after thirty minutes of cruising flight, the ammeter should be indicating less than two needle widths of charging current. If the charging rate were to remain above this value on a long flight, the battery would overheat and evaporate the electrolyte at an excessive rate. Electronic components in the electrical system could be adversely affected by higher than normal voltage if a faulty voltage regulator setting is causing the overcharging. To preclude these possibilities, an over-voltage sensor will automatically shut down the alternator and the over-voltage warning light will illuminate if the charge voltage reaches approximately 16 volts.

Assuming that the malfunction was only momentary, an attempt should be made to reactivate the alternator system. To do this, turn both sides of the master switch off and then on again. If the problem no longer exists, normal alternator charging will resume and the warning light will go off. If the light comes on again, a malfunction is confirmed. In this event, the flight should be terminated and/or the current drain on the battery minimized because the battery can supply the electrical system for only a limited period of time. If the emergency occurs at night, power must be conserved for later use of the landing light and flaps during landing.

INSUFFICIENT RATE OF CHARGE.

If the ammeter indicates a continuous discharge rate in flight, the alternator is not supplying power to the system and should be shut down since the alternator field circuit may be placing an unnecessary load on the system. All non-essential equipment should be turned "OFF" and the flight terminated as soon as practical.

ROUGH ENGINE OPERATION OR LOSS OF POWER.

CARBURETOR ICING.

A gradual loss of RPM and eventual engine roughness may result from the formation of carburetor ice. To clear the ice, apply full throttle and pull the carburetor heat knob full out until the engine runs smoothly; then remove carburetor heat and readjust the throttle. If conditions require the continued use of carburetor heat in cruise flight, use the minimum amount of heat necessary to prevent ice from forming and lean the mixture slightly for smoothest engine operation.

SPARK PLUG FOULING.

A slight engine roughness in flight may be caused by one or more spark plugs becoming fouled by carbon or lead deposits. This may be verified by turning the ignition switch momentarily from "BOTH" to either "L" or "R" position. An obvious power loss in single ignition operation is evidence of spark plug or magneto trouble. Assuming that spark plugs are the more likely cause, lean the mixture to the normal lean setting for cruising flight. If the problem does not clear up in several minutes, determine if a richer mixture setting will produce smoother operation. If not, proceed to the nearest airport for repairs using the "BOTH" position of the ignition switch unless extreme roughness dictates the use of a single ignition position.

MAGNETO MALFUNCTION.

A sudden engine roughness or misfiring is usually evidence of magneto problems. Switching from "BOTH" to either "L" or "R" ignition switch position will identify which magneto is malfunctioning. Select different power settings and enrichen the mixture to determine if continued operation on "BOTH" magnetos is practicable. If not, switch to the good magneto and proceed to the nearest airport for repairs.

LOW OIL PRESSURE.

If low oil pressure is accompanied by normal oil temperature, there is a possibility the oil pressure gage or relief valve is malfunctioning. A leak in the line to the gage is not necessarily cause for an immediate precautionary landing because an orifice in this line will prevent a sudden loss of oil from the engine sump. However, a landing at the nearest airport would be advisable to inspect the source of trouble.

If a total loss of oil pressure is accompanied by a rise in oil temperature, there is good reason to suspect an engine failure is imminent. Reduce engine power immediately and select a suitable forced landing field. Leave the engine running at low power during the approach, using only the minimum power required to reach the desired touchdown spot.

FORCED LANDINGS.

PRECAUTIONARY LANDING WITH ENGINE POWER.

Before attempting an "off airport" landing, one should drag the landing area at a safe but low altitude to inspect the terrain for obstructions and surface conditions, proceeding as follows:

- (1) Drag over selected field with flaps 20° and 70 MPH airspeed, noting the preferred area for touchdown for the next landing approach. Then retract flaps upon reaching a safe altitude and airspeed.
- (2) On downwind leg, turn off all switches except the ignition and master switches.
- (3) Approach with flaps 40° at 65 MPH.
- (4) Unlatch cabin doors prior to final approach.
- (5) Before touchdown, turn ignition and master switches "OFF."
- (6) Land in a slightly tail-low attitude.

EMERGENCY LANDING WITHOUT ENGINE POWER.

If an engine stoppage occurs, establish a flaps up glide at 70 MPH. If time permits, attempt to restart the engine by checking for fuel quantity, proper fuel shutoff valve position, and mixture control setting. Also check that engine primer is full in and locked and ignition switch is properly positioned.

If all attempts to restart the engine fail and a forced landing is imminent, select a suitable field and prepare for the landing as follows:

- (1) Pull mixture control to idle cut-off position.
- (2) Turn fuel shutoff valve to "OFF."
- (3) Turn all switches "OFF", except master switch.
- (4) Approach at 70 MPH.
- (5) Extend wing flaps as necessary within gliding distance of field.
- (6) Turn master switch "OFF."
- (7) Unlatch cabin doors prior to final approach.
- (8) Land in a slightly tail-low attitude.
- (9) Apply heavy braking.

DITCHING.

Prepare for ditching by securing or jettisoning heavy objects located in the baggage area, and collect folded coats or cushions for protection of occupant's face at touchdown. Transmit Mayday message on 121.5 MHz. giving location and intentions.

- (1) Plan approach into wind if winds are high and seas are heavy. With heavy swells and light wind, land parallel to swells.
- (2) Approach with flaps 40° and sufficient power for a 300 ft./min. rate of descent at 65 MPH.
- (3) Unlatch the cabin doors.
- (4) Maintain a continuous descent until touchdown in level attitude. Avoid a landing flare because of difficulty in judging airplane height over a water surface.
- (5) Place folded coat or cushion in front of face at time of touchdown.
- (6) Evacuate airplane through cabin doors. If necessary, open window to flood cabin compartment for equalizing pressure so that door can be opened.
- (7) Inflate life vests and raft (if available) after evacuation of cabin. The aircraft can not be depended on for flotation for more than a few minutes.

DISORIENTATION IN CLOUDS.

When flying in marginal weather, the pilot should make sure that the Wing Leveler (if installed) control knob is "ON." However, if the airplane is not equipped with this device or gyro horizon and directional gyro instruments, the pilot will have to rely on the turn coordinator (or turn and bank indicator) if he inadvertently flies into clouds. The following instructions assume that only one of the latter two instruments is available.

EXECUTING A 180° TURN IN CLOUDS.

Upon entering the clouds, an immediate plan should be made to turn back as follows:

- (1) Note the time of the minute hand and observe the position of the sweep second hand on the clock.
- (2) When the sweep second hand indicates the nearest half-minute, initiate a standard rate left turn, holding the turn coordinator symbolic airplane wing opposite the lower left index mark for 60 seconds. Then roll back to level flight by leveling the miniature airplane.
- (3) Check accuracy of the turn by observing the compass heading which should be the reciprocal of the original heading.
- (4) If necessary, adjust heading primarily with skidding motions rather than rolling motions so that the compass will read more accurately.
- (5) Maintain altitude and airspeed by cautious application of elevator control. Avoid overcontrolling by keeping the hands off the control wheel and steering only with rudder.

EMERGENCY LET-DOWNS THROUGH CLOUDS.

If possible, obtain radio clearance for an emergency descent through clouds. To guard against a spiral dive, choose an easterly or westerly heading to minimize compass card swings due to changing bank angles. In addition, keep hands off the control wheel and steer a straight course with rudder control by monitoring the turn coordinator. Occasionally check the compass heading and make minor corrections to hold an approximate course. Before descending into the clouds, set up a stabilized let-down condition as follows:

- (1) Apply full rich mixture.
- (2) Use full carburetor heat.
- (3) Reduce power to set up a 500 to 800 ft./min. rate of descent.
- (4) Adjust the elevator trim tab for a stabilized descent at 80 MPH.

- (5) Keep hands off the control wheel.
- (6) Monitor turn coordinator and make corrections by rudder alone.
- (7) Check trend of compass card movement and make cautious corrections with rudder to stop the turn.
- (8) Upon breaking out of clouds, resume normal cruising flight.

RECOVERY FROM A SPIRAL DIVE.

If a spiral is encountered, proceed as follows:

- (1) Close the throttle.
- (2) Stop the turn by using coordinated aileron and rudder control to align the symbolic airplane in the turn coordinator with the horizon reference line.
- (3) Cautiously apply elevator back pressure to slowly reduce the indicated airspeed to 80 MPH.
- (4) Adjust the elevator trim control to maintain an 80 MPH glide.
- (5) Keep hands off the control wheel, using rudder control to hold a straight heading.
- (6) Apply carburetor heat.
- (7) Clear engine occasionally, but avoid using enough power to disturb the trimmed glide.
- (8) Upon breaking out of clouds, apply normal cruising power and resume flight.

FIRES.

ENGINE FIRE DURING START ON GROUND.

Improper starting procedures such as pumping the throttle during a difficult cold weather start can cause a backfire which could ignite fuel that has accumulated in the intake duct. In this event, proceed as follows:

- (1) Continue cranking in an attempt to get a start which would suck the flames and accumulated fuel through the carburetor and into the engine.
- (2) If the start is successful, run the engine at 1700 RPM for a few minutes before shutting it down to inspect the damage.
- (3) If engine start is unsuccessful, continue cranking for two or three minutes with throttle full open while ground attendants obtain

fire extinguishers.

(4) When ready to extinguish fire, release the starter switch and turn off master switch, ignition switch, and fuel shutoff valve.

(5) Smother flames with fire extinguisher, seat cushion, wool blanket, or loose dirt. If practical, try to remove carburetor air filter if it is ablaze.

(6) Make a thorough inspection of fire damage, and repair or replace damaged components before conducting another flight.

ENGINE FIRE IN FLIGHT.

Although engine fires are extremely rare in flight, the following steps should be taken if one is encountered:

- (1) Pull mixture control to idle cut-off.
- (2) Turn fuel shutoff valve "OFF."
- (3) Turn master switch "OFF."
- (4) Establish a 100 MPH glide.
- (5) Close cabin heat control.
- (6) Select a field suitable for a forced landing.
- (7) If fire is not extinguished, increase glide speed in an attempt to find an airspeed that will provide an incombustible mixture.
- (8) Execute a forced landing as described in paragraph Emergency Landing Without Engine Power. Do not attempt to restart the engine.

ELECTRICAL FIRE IN FLIGHT.

The initial indication of an electrical fire is the odor of burning insulation. The immediate response should be to turn the master switch "OFF." Then close off ventilating air as much as practicable to reduce the chances of a sustained fire.

If electrical power is indispensable for the flight, an attempt may be made to identify and cut off the defective circuit as follows:

- (1) Master Switch -- "OFF."
- (2) All other switches (except ignition switch) -- "OFF."
- (3) Check condition of fuses and circuit breaker to identify faulty circuit if possible. Leave faulty circuit deactivated.
- (4) Master Switch -- "ON."
- (5) Select switches "ON" successively, permitting a short time delay to elapse after each switch is turned on until the short circuit is localized.
- (6) Make sure fire is completely extinguished before opening vents.

FLIGHT IN ICING CONDITIONS.

Although flying in known icing conditions is prohibited, an unexpected icing encounter should be handled as follows:

- (1) Turn pitot heat switch "ON" (if installed).
- (2) Turn back or change altitude to obtain an outside air temperature that is less conducive to icing.
- (3) Pull cabin heat control full out to obtain windshield defroster airflow. Adjust cabin air control to get maximum defroster heat and airflow.
- (4) Open the throttle to increase engine speed and minimize ice build-up on propeller blades.
- (5) Watch for signs of carburetor air filter ice and apply carburetor heat as required. An unexplained loss in engine speed could be caused by carburetor ice or air intake filter ice. Lean the mixture for maximum RPM if carburetor heat is used continuously.
- (6) Plan a landing at the nearest airport. With an extremely rapid ice build-up, select a suitable "off airport" landing site.
- (7) With an ice accumulation of 1/4 inch or more on the wing leading edges, be prepared for significantly higher stall speed.
- (8) Leave wing flaps retracted. With a severe ice build-up on the horizontal tail, the change in wing wake airflow direction caused by wing flap extension could result in a loss of elevator effectiveness.
- (9) Open left window and, if practical, scrape ice from a portion of the windshield for visibility in the landing approach.
- (10) Perform a landing approach using a forward slip, if necessary, for improved visibility.
- (11) Approach at 70 to 80 MPH, depending upon the amount of ice accumulation.
- (12) Perform a landing in level attitude.

Section IV

OPERATING LIMITATIONS

OPERATIONS AUTHORIZED.

Your Cessna exceeds the requirements of airworthiness as set forth by the United States Government, and is certificated under FAA Type Certificate No. 3A19 as Cessna Model No. 150L.

The airplane may be equipped for day, night, VFR, or IFR operation. Your Cessna Dealer will be happy to assist you in selecting equipment best suited to your needs.

Your airplane must be operated in accordance with all FAA-approved markings and placards in the airplane. If there is any information in this section which contradicts the FAA-approved markings and placards, it is to be disregarded.

MANEUVERS-UTILITY CATEGORY.

This airplane is certificated in the utility category and is designed for limited aerobatic flight. In the acquisition of various certificates such as commercial pilot, instrument pilot and flight instructor, certain maneuvers are required by the FAA. All of these maneuvers are permitted in this airplane. In connection with the foregoing, the following gross weight and flight load factors apply, with maximum entry speeds for maneuvers as shown:

Gross Weight	1600 lbs
Flight Load Factor, *Flaps Up	+4.4 -1.76
Flight Load Factor, *Flaps Down	+3.5

*The design load factors are 150% of the above, and in all cases, the structure meets or exceeds design loads.

No aerobatic maneuvers are approved except those listed below:

<u>MANEUVER</u>	<u>MAXIMUM ENTRY SPEED*</u>
Chandelles	109 MPH (95 knots)
Lazy Eights	109 MPH (95 knots)
Steep Turns	109 MPH (95 knots)
Spins	Use Slow Deceleration
Stalls (Except Whip Stalls)	Use Slow Deceleration

* Higher speeds can be used if abrupt use of the controls is avoided.

Aerobatics that may impose high loads should not be attempted. The important thing to bear in mind in flight maneuvers is that the airplane is clean in aerodynamic design and will build up speed quickly with the nose down. Proper speed control is an essential requirement for execution of any maneuver, and care should always be exercised to avoid excessive speed which in turn can impose excessive loads. In the execution of all maneuvers, avoid abrupt use of controls.

AIRSPED LIMITATIONS (CAS).

The following is a list of the certificated calibrated airspeed (CAS) limitations for the airplane.

Never Exceed Speed (glide or dive, smooth air)	162 MPH
Maximum Structural Cruising Speed	120 MPH
Maximum Speed, Flaps Extended	100 MPH
*Maneuvering Speed	109 MPH

*The maximum speed at which you may use abrupt control travel.

AIRSPED INDICATOR MARKINGS.

The following is a list of the certificated calibrated airspeed markings (CAS) for the airplane.

Never Exceed (glide or dive, smooth air)	162 MPH (red line)
Caution Range	120-162 MPH (yellow arc)
Normal Operating Range	56-120 MPH (green arc)
Flap Operating Range	49-100 MPH (white arc)

ENGINE OPERATION LIMITATIONS.

Power and Speed 100 BHP at 2750 RPM

ENGINE INSTRUMENT MARKINGS.

OIL TEMPERATURE GAGE.

Normal Operating Range Green Arc
Maximum Allowable 240°F (red line)

OIL PRESSURE GAGE.

Minimum Idling 10 PSI (red line)
Normal Operating Range 30-60 PSI (green arc)
Maximum 100 PSI (red line)

FUEL QUANTITY INDICATORS.

Empty (1.75 gallons unusable each standard tank) . . . E (red line)
(1.50 gallons unusable each long range tank)

TACHOMETER.

Normal Operating Range:
At sea level 2000-2550 RPM (inner green arc)
At 5000 feet 2000-2650 RPM (middle green arc)
At 10,000 feet 2000-2750 RPM (outer green arc)
Maximum Allowable 2750 RPM (red line)

SUCTION GAGE (GYRO SYSTEM).

Normal Operating Range 4.6 - 5.4 in. Hg (green arc)

WEIGHT AND BALANCE.

The following information will enable you to operate your Cessna within the prescribed weight and center of gravity limitations. To figure the weight and balance for your particular airplane, use the Sample Problem, Loading Graph, and Center of Gravity Moment Envelope as follows:

Take the licensed empty weight and moment from the Weight and Balance and Installed Equipment Data sheet (or changes noted on FAA Form 337) carried in your airplane, and write them down in the column titled YOUR AIRPLANE on the Sample Loading Problem.

NOTE

The Weight and Balance and Installed Equipment Data sheet is included in the aircraft file. In addition to the licensed empty weight and moment noted on this sheet, the c.g. arm (fuselage station) is also shown, but need not be used on the Sample Loading Problem. The moment shown on the sheet must be divided by 1000 and this value used as the moment/1000 on the loading problem.

Use the Loading Graph to determine the moment/1000 for each additional item to be carried, then list these on the loading problem.

NOTE

Loading Graph information is based on seats positioned for average occupants and baggage loaded in the center of the baggage area. For other than average loading situations, the Sample Loading Problem lists fuselage stations for these items to indicate their forward and aft c.g. range limitation (seat travel or baggage area limitation). Additional moment calculations, based on the actual weight and c.g. arm (fuselage station) of the item being loaded, must be made if the position of the load is different from that shown on the Loading Graph.

Total the weights and moments/1000 and plot these values on the Center of Gravity Moment Envelope to determine whether the point falls within the envelope, and if the loading is acceptable.

LOADING ARRANGEMENTS

* Pilot or passenger center of gravity on adjustable seats positioned for average occupant. Numbers in parentheses indicate forward and aft limits of occupant center of gravity range.

** Arms measured to the center of the areas shown.

NOTE

The aft baggage wall (approximate station 94) can be used as a convenient interior reference point for determining the location of baggage area fuselage stations.

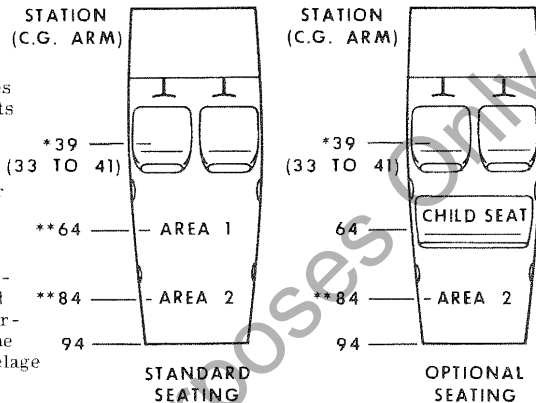

BAGGAGE LOADING AND TIE-DOWN

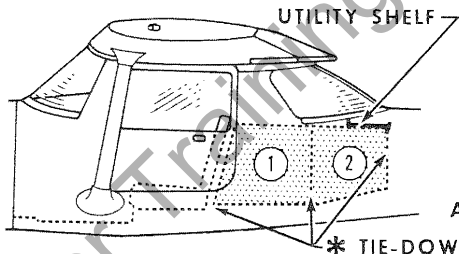

**BAGGAGE AREA
MAXIMUM ALLOWABLE LOADS**

- AREA ① = 120 POUNDS
- AREA ② = 40 POUNDS
- AREAS ① + ② = 120 POUNDS

*** TIE-DOWN NET ATTACH POINTS**

* A tie-down net is provided to secure baggage in the baggage area. The net attaches to six tie-down rings. Two rings are located on the floor just aft of the seat backs and one ring is located two inches above the floor on each cabin wall at the aft end of area ①. Two additional rings are located at the top, aft end of area ②. At least four rings should be used to restrain the maximum baggage load of 120#.

If the airplane is equipped with an optional utility shelf, it should be removed prior to loading and tying down large baggage items. (Slide the tab of the locking clips on each end of the shelf to disengage the shelf from the aircraft structure.) After baggage is loaded and secured, either stow the shelf or, if space permits, install it for storing small articles.

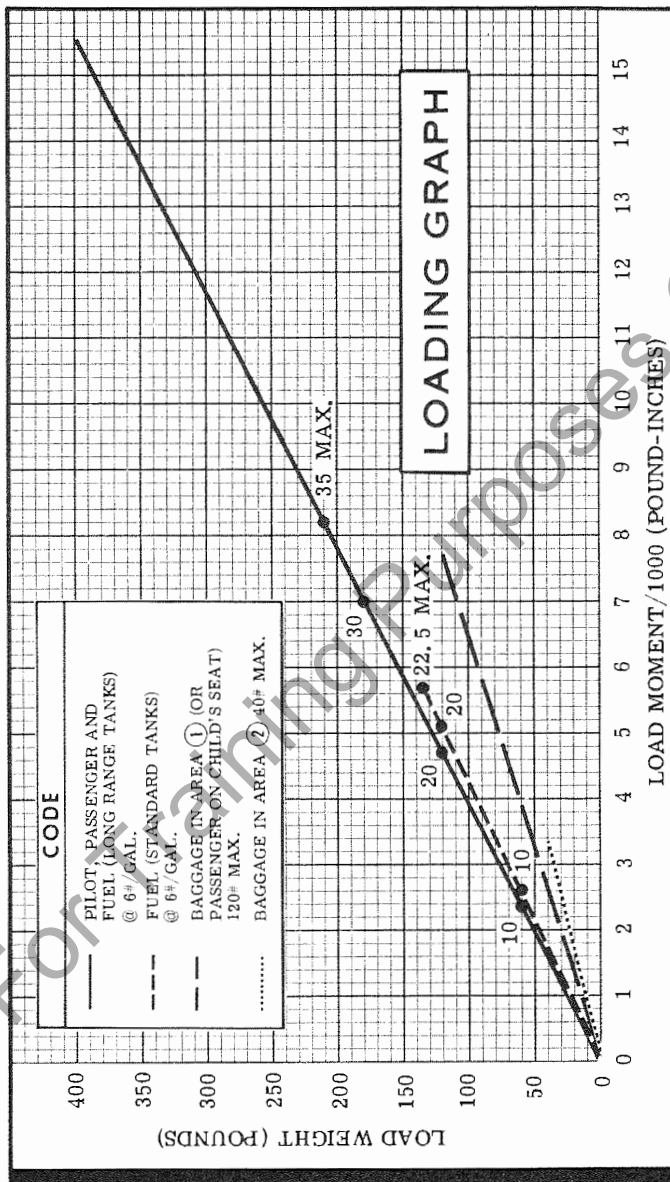

NOTES: (1) Line representing adjustable seats shows the pilot or passenger center of gravity on adjustable seats positioned for an average occupant. Refer to the Loading Arrangements Diagram for forward and aft limits of occupant c.g. range.

(2) Engine Oil: 6 Qts. = 11 lbs. at -0.1 Moment/1000.

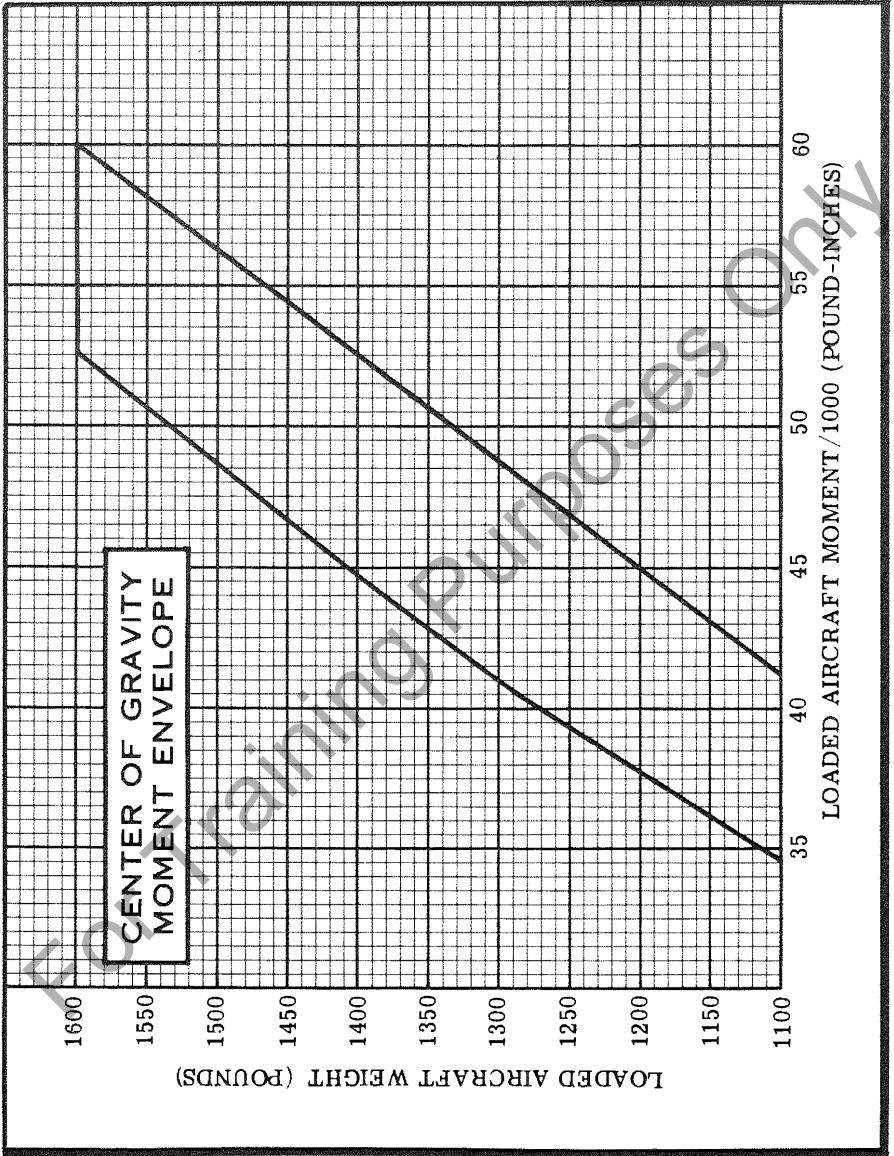

Section V

CARE OF THE AIRPLANE

If your airplane is to retain that new-plane performance and dependability, certain inspection and maintenance requirements must be followed. It is wise to follow a planned schedule of lubrication and preventive maintenance based on climatic and flying conditions encountered in your locality.

Keep in touch with your Cessna Dealer, and take advantage of his knowledge and experience. He knows your airplane and how to maintain it. He will remind you when lubrications and oil changes are necessary and about other seasonal and periodic services.

GROUND HANDLING.

The airplane is most easily and safely maneuvered by hand with the tow-bar attached to the nose wheel. When towing with a vehicle, do not exceed the nose gear turning angle of 30° either side of center, or damage to the gear will result. If the airplane is towed or pushed over a rough surface during hangaring, watch that the normal cushioning action of the nose strut does not cause excessive vertical movement of the tail and the resulting contact with low hangar doors or structure. A flat nose tire or deflated strut will also increase tail height.

MOORING YOUR AIRPLANE.

Proper tie-down is the best precaution against damage to your parked airplane by gusty or strong winds. To tie down your airplane securely, proceed as follows:

- (1) Set parking brake and install control wheel lock.
- (2) Install a surface control lock between each aileron and flap.
- (3) Tie sufficiently strong ropes or chains (700 pounds tensile strength) to wing and tail tie-down fittings, and secure each rope

to ramp tie-down.

- (4) Install a surface control lock over the fin and rudder.
- (5) Install a pitot tube cover.
- (6) Tie a rope to an exposed portion of the engine mount and secure the opposite end to a ramp tie-down.

WINDSHIELD-WINDOWS.

The plastic windshield and windows should be cleaned with an aircraft windshield cleaner. Apply the cleaner sparingly with soft cloths, and rub with moderate pressure until all dirt, oil scum and bug stains are removed. Allow the cleaner to dry, then wipe it off with soft flannel cloths.

If a windshield cleaner is not available, the plastic can be cleaned with soft cloths moistened with Stoddard solvent to remove oil and grease.

NOTE

Never use gasoline, benzine, alcohol, acetone, carbon tetrachloride, fire extinguisher or anti-ice fluid, lacquer thinner or glass cleaner to clean the plastic. These materials will attack the plastic and may cause it to craze.

Follow by carefully washing with a mild detergent and plenty of water. Rinse thoroughly, then dry with a clean moist chamois. Do not rub the plastic with a dry cloth since this builds up an electrostatic charge which attracts dust. Waxing with a good commercial wax will finish the cleaning job. A thin, even coat of wax, polished out by hand with clean soft flannel cloths, will fill in minor scratches and help prevent further scratching.

Do not use a canvas cover on the windshield unless freezing rain or sleet is anticipated since the cover may scratch the plastic surface.

PAINTED SURFACES.

The painted exterior surfaces of your new Cessna have a durable, long lasting finish and, under normal conditions, require no polishing or buffing. Approximately 15 days are required for the paint to cure completely; in most cases, the curing period will have been completed prior to delivery of the airplane. In the event that polishing or buffing is required within the curing period, it is recommended that the work be done

by someone experienced in handling uncured paint. Any Cessna Dealer can accomplish this work.

Generally, the painted surfaces can be kept bright by washing with water and mild soap, followed by a rinse with water and drying with cloths or a chamois. Harsh or abrasive soaps or detergents which cause corrosion or scratches should never be used. Remove stubborn oil and grease with a cloth moistened with Stoddard solvent.

Waxing is unnecessary to keep the painted surfaces bright. However, if desired, the airplane may be waxed with a good automotive wax. A heavier coating of wax on the leading edges of the wings and tail and on the engine nose cap and propeller spinner will help reduce the abrasion encountered in these areas.

When the airplane is parked outside in cold climates and it is necessary to remove ice before flight, care should be taken to protect the painted surfaces during ice removal with chemical liquids. A 50-50 solution of isopropyl alcohol and water will satisfactorily remove ice accumulations without damaging the paint. A solution with more than 50% alcohol is harmful and should be avoided. While applying the de-icing solution, keep it away from the windshield and cabin windows since the alcohol will attack the plastic and may cause it to craze.

ALUMINUM SURFACES.

The clad aluminum surfaces of your Cessna require only minimum care to keep them bright and clean. The airplane may be washed with water to remove dirt; oil and grease may be removed with gasoline, naphtha, carbon tetrachloride or other non-alkaline solvents. Dulled aluminum surfaces may be cleaned effectively with an aircraft aluminum polish.

After cleaning, and periodically thereafter, waxing with a good automotive wax will preserve the bright appearance and retard corrosion. Regular waxing is especially recommended for airplanes operated in salt water areas as a protection against corrosion.

PROPELLER CARE.

Preflight inspection of propeller blades for nicks, and wiping them

occasionally with an oily cloth to clean off grass and bug stains will assure long, trouble-free service. Small nicks on the blades, particularly near the tips and on the leading edges, should be dressed out as soon as possible since these nicks produce stress concentrations, and if ignored, may result in cracks. Never use an alkaline cleaner on the blades; remove grease and dirt with carbon tetrachloride or Stoddard solvent.

INTERIOR CARE.

To remove dust and loose dirt from the upholstery, headliner, and carpet, clean the interior regularly with a vacuum cleaner.

Blot up any spilled liquid promptly, with cleansing tissue or rags. Don't pat the spot; press the blotting material firmly and hold it for several seconds. Continue blotting until no more liquid is taken up. Scrape off sticky materials with a dull knife, then spot-clean the area.

Oily spots may be cleaned with household spot removers, used sparingly. Before using any solvent, read the instructions on the container and test it on an obscure place on the fabric to be cleaned. Never saturate the fabric with a volatile solvent; it may damage the padding and backing materials.

Soiled upholstery and carpet may be cleaned with foam-type detergent, used according to the manufacturer's instructions. To minimize wetting the fabric, keep the foam as dry as possible and remove it with a vacuum cleaner.

The plastic trim, instrument panel and control knobs need only be wiped off with a damp cloth. Oil and grease on the control wheel and control knobs can be removed with a cloth moistened with Stoddard solvent. Volatile solvents, such as mentioned in paragraphs on care of the windshield, must never be used since they soften and craze the plastic.

FLYABLE STORAGE.

Aircraft placed in non-operational storage for a maximum of 30 days or those which receive only intermittent operational use for the first 25 hours are considered in flyable storage status. Every seventh day during these periods, the propeller should be rotated by hand through five revolu-

tions. This action "limbers" the oil and prevents any accumulation of corrosion on engine cylinder walls.

IMPORTANT

For maximum safety, check that the ignition switch is OFF, the throttle is closed, the mixture control is in the idle cut-off position, and the airplane is secured before rotating the propeller by hand. Do not stand within the arc of the propeller blades while turning the propeller.

After 30 days, the aircraft should be flown for 30 minutes or a ground runup should be made just long enough to produce an oil temperature within the lower green arc range. Excessive ground runup should be avoided.

Engine runup also helps to eliminate excessive accumulations of water in the fuel system and other air spaces in the engine. Keep fuel tanks full to minimize condensation in the tanks. Keep the battery fully charged to prevent the electrolyte from freezing in cold weather. If the aircraft is to be stored temporarily, or indefinitely, refer to the Service Manual for proper storage procedures.

INSPECTION SERVICE AND INSPECTION PERIODS.

With your airplane you will receive a Customer Care Program book. Coupons attached to the Program book entitle you to an initial inspection and the first 100-hour inspection at no charge. If you take delivery from your Dealer, he will perform the initial inspection before delivery of the airplane to you. If you pick up the airplane at the factory, plan to take it to your Dealer reasonably soon after you take delivery on it. This will permit him to check it over and to make any minor adjustments that may appear necessary. Also, plan an inspection by your Dealer at 100 hours or 180 days, whichever comes first. This inspection also is performed by your Dealer for you at no charge. While these important inspections will be performed for you by any Cessna Dealer, in most cases you will prefer to have the Dealer from whom you purchased the airplane accomplish this work.

Federal Aviation Regulations require that all airplanes have a periodic (annual) inspection as prescribed by the administrator, and performed by a person designated by the administrator. In addition, 100-hour periodic

inspections made by an "appropriately-rated mechanic" are required if the airplane is flown for hire. The Cessna Aircraft Company recommends the 100-hour periodic inspection for your airplane. The procedure for this 100-hour inspection has been carefully worked out by the factory and is followed by the Cessna Dealer Organization. The complete familiarity of the Cessna Dealer Organization with Cessna equipment and with factory-approved procedures provides the highest type of service possible at lower cost.

AIRCRAFT FILE.

There are miscellaneous data, information and licenses that are a part of the aircraft file. The following is a check list for that file. In addition, a periodic check should be made of the latest Federal Aviation Regulations to ensure that all data requirements are met.

A. To be displayed in the aircraft at all times:

- (1) Aircraft Airworthiness Certificate (FAA Form 8100-2).
- (2) Aircraft Registration Certificate (FAA Form 8050-3).
- (3) Aircraft Radio Station License, if transmitter installed (FCC Form 556).

B. To be carried in the aircraft at all times:

- (1) Weight and Balance, and associated papers (latest copy of the Repair and Alteration Form, FAA Form 337, if applicable).
- (2) Aircraft Equipment List.

C. To be made available upon request:

- (1) Aircraft Log Book.
- (2) Engine Log Book.

NOTE

Cessna recommends that these items, plus the Owner's Manual, Power Computer, Pilot's Check List, Customer Care Program book and Customer Care Card, be carried in the aircraft at all times.

Most of the items listed are required by the United States Federal Aviation Regulations. Since the regulations of other nations may require other documents and data, owners of exported aircraft should check with

their own aviation officials to determine their individual requirements.

MAA PLATE/FINISH AND TRIM PLATE.

Information concerning the Type Certificate Number (TC), Production Certificate Number (PC), Model Number and Serial Number of your particular aircraft can be found on the MAA (Manufacturers Aircraft Association) plate located on the cabin floor below the left rear corner of the pilot's seat. The plate is accessible by sliding the seat forward and lifting the carpet in this area.

A Finish and Trim plate contains a code describing the interior color scheme and exterior paint combination of the aircraft. The code may be used in conjunction with an applicable Parts Catalog if finish and trim information is needed. This plate is also located on the cabin floor near the left rear corner of the pilot's seat.

LUBRICATION AND SERVICING PROCEDURES

Specific servicing information is provided here for items requiring daily attention. A Servicing Intervals Check List is included to inform the pilot when to have other items checked and serviced.

DAILY

FUEL TANK FILLERS:

Service after each flight with 80/87 minimum grade fuel. The capacity of each wing tank is 13 gallons for standard fuel tanks, 19 gallons for optional long range tanks. Due to crossfeeding between fuel tanks, the tanks should be re-topped after each refueling to assure maximum capacity.

FUEL STRAINER:

Before first flight of the day and after each refueling, pull out fuel strainer drain knob (located just inside cowl access door) for about four seconds, to clear fuel strainer of possible water and sediment. Release drain knob, then check that strainer drain is closed after draining. If water is observed, there is a possibility that the wing tank sumps contain water. Thus, the wing tank sump drain plugs and fuel line drain plug should be removed to check for presence of water.

OIL DIPSTICK:

Check oil level before each flight. Do not operate on less than 4 quarts. To minimize loss of oil through breather, fill to 5 quart level for normal flights of less than 3 hours. For extended flight, fill to 6 quarts. If optional oil filter is installed, one additional quart is required when the filter element is changed.

OIL FILLER:

When preflight check shows low oil level, service with aviation grade engine oil; SAE 40 above 40°F and SAE 10W30 or SAE 20 below 40°F. (Multi-viscosity oil with a range of SAE 10W30 is recommended for improved starting in cold weather.) Detergent or dispersant oil, conforming to Continental Motors Specification MHS-24A, must be used. Your Cessna Dealer can supply approved brands of oil.

NOTE

Your Cessna was delivered from the factory with a corrosion preventive aircraft engine oil. If oil must be added during the first 25 hours, use only aviation grade straight mineral oil (non-detergent) conforming to Specification No. MIL-L-6082.

SERVICING INTERVALS CHECK LIST

FIRST 25 HOURS

ENGINE OIL SUMP AND OIL FILTER -- After first 25 hours of operation, drain engine oil sump and clean the oil pressure screen. If an optional oil filter is installed, change filter element at this time. Refill sump with straight mineral oil (non-detergent) and use until a total of 50 hours have accumulated or oil consumption has stabilized, then change to detergent oil.

EACH 50 HOURS

BATTERY -- Check and service. Check more often (at least every 30 days) if operating in hot weather.

ENGINE OIL SUMP AND OIL FILTER -- Change engine oil and replace filter element. If optional oil filter is not installed, change oil and clean the oil pressure screen every 25 hours. Change engine oil at least every four months even though less than the recommended hours have accumulated. Reduce periods for prolonged operation in dusty areas, cold climates, or when short flights and long idle periods result in sludging conditions.

CARBURETOR AIR FILTER -- Clean or replace. Under extremely dusty conditions, daily maintenance of the filter is recommended.

NOSE GEAR TORQUE LINKS -- Lubricate. When operating under dusty conditions, more frequent lubrication is recommended.

EACH 100 HOURS

SPARK PLUGS -- Clean, test and regap.

BRAKE MASTER CYLINDERS -- Check and fill.

SHIMMY DAMPENER -- Check and fill.

FUEL STRAINER -- Disassemble and clean.

FUEL TANK SUMP DRAINS -- Drain water and sediment.

FUEL LINE DRAIN PLUG -- Drain water and sediment.

SUCTION RELIEF VALVE INLET FILTER (OPT) -- Clean. Replace at engine overhaul period.

SERVICING INTERVALS CHECK LIST

(Continued)

EACH 500 HOURS

VACUUM SYSTEM AIR FILTER (OPT) -- Replace filter element. Replace sooner if suction gage reading drops to 4.6 in. Hg.
WHEEL BEARINGS -- Lubricate at first 100 hours and at 500 hours thereafter. Reduce lubrication interval to 100 hours when operating in dusty or seacoast areas, during periods of extensive taxiing, or when numerous take-offs and landings are made.

AS REQUIRED

NOSE GEAR SHOCK STRUT -- Keep filled with hydraulic fluid and inflated with air to 20 psi. Do not over-inflate.

ADDITIONAL SERVICE AND TEST REGULATIONS

Service intervals of items in the preceding check list are recommended by The Cessna Aircraft Company. Government regulations may require that additional items be inspected, serviced or tested at specific intervals for various types of flight operations. For these regulations, owners should check with aviation officials in the country where the aircraft is being operated.

OWNER FOLLOW-UP SYSTEM



Your Cessna Dealer has an owner follow-up system to notify you when he receives information that applies to your Cessna. In addition, if you wish, you may choose to receive similar notification, in the form of Service Letters, directly from the Cessna Customer Services Department. A subscription form is supplied in your Customer Care Program book for your use, should you choose to request this service. Your Cessna Dealer will be glad to supply you with details concerning these follow-up programs, and stands ready through his Service Department to supply you with fast, efficient, low cost service.

PUBLICATIONS

Various publications and flight operation aids are furnished in the aircraft when delivered from the factory. These items are listed below.

- OWNER'S MANUALS FOR YOUR AIRCRAFT ELECTRONICS
- POWER COMPUTER
- SALES AND SERVICE DEALER DIRECTORY
- DO'S AND DON'TS ENGINE BOOKLET

The following additional publications, plus many other supplies that are applicable to your aircraft, are available from your Cessna Dealer.

- SERVICE MANUALS AND PARTS CATALOGS FOR YOUR AIRCRAFT ENGINE AND ACCESSORIES ELECTRONICS

Your Cessna Dealer has a current catalog of all available Customer Services Supplies, many of which he keeps on hand. If supplies are not in stock, your Cessna Dealer will be happy to order for you.

For Training Purposes Only

Section VI

OPERATIONAL DATA

The operational data shown on the following pages are compiled from actual tests with the airplane and engine in good condition, and using average piloting technique and best power mixture. You will find this data a valuable aid when planning your flights.

To realize the maximum usefulness from your Cessna, you should take advantage of its high cruising speeds. However, if range is of primary importance, it may pay you to fly at a low cruising RPM, thereby increasing your range and allowing you to make the trip non-stop with ample fuel reserve. The cruise performance table (figure 6-4) should be used to solve flight planning problems of this nature.

In the table (figure 6-4), range and endurance are given for lean mixture from 2500 feet to 12,500 feet. All figures are based on zero wind, 22.5 and 35.0 gallons of fuel for cruise, McCauley 1A101/HCM6948 propeller, 1600 pounds gross weight, and standard atmospheric conditions. Mixture is leaned to maximum RPM. Allowances for fuel reserve, headwinds, take-offs and climb, and variations in mixture leaning technique should be made as no allowances are shown on the chart. Other indeterminate variables such as carburetor metering characteristics, engine and propeller conditions, externally-mounted optional equipment and turbulence of the atmosphere may account for variations of 10% or more in maximum range.







Remember that the charts contained herein are based on standard day conditions. For more precise power, fuel consumption, and endurance information, consult the Power Computer supplied with your aircraft. With the Power Computer, you can easily take into account temperature variations from standard at any flight altitude.

AIRSPEED CORRECTION TABLE

FLAPS UP										
IAS-MPH	50	60	70	80	90	100	110	120	130	140
CAS-MPH	53	60	69	78	87	97	107	117	128	138
FLAPS DOWN										
IAS-MPH	40	50	60	70	80	90	100			
CAS-MPH	40	50	61	72	83	94	105			

Figure 6-1.

STALL SPEEDS – MPH CAS

Gross Weight 1600 lbs.	ANGLE OF BANK			
CONDITION	 0°	 20°	 40°	 60°
Flaps UP 	55	57	63	78
Flaps 20° 	49	51	56	70
Flaps 40° 	48	49	54	67

POWER OFF — AFT CG

Figure 6-2.

TAKE-OFF DISTANCE

GROSS WT. LBS.	IAS 50 FT. MPH	HEAD WIND KNOTS	AT SEA LEVEL & 59° F.		AT 2500 FT. & 50° F.		AT 5000 FT. & 41° F.		AT 7500 FT. & 32° F.	
			GROUND RUN	TOTAL TO CLEAR 50 FT. OBS	GROUND RUN	TOTAL TO CLEAR 50 FT. OBS	GROUND RUN	TOTAL TO CLEAR 50 FT. OBS	GROUND RUN	TOTAL TO CLEAR 50 FT. OBS
1600	70	0 10 20	735 500 305	1385 1035 730	910 630 395	1660 1250 890	1115 780 505	1985 1510 1090	1360 970 640	2440 1875 1375

NOTES: 1. Increase the distances 10% for each 35° F. increase in temperature above standard for the particular altitude.
 2. For operation on a dry, grass runway, increase distances (both "ground run" and "total to clear 50 ft. obstacle") by 7% of the "total to clear 50 ft. obstacle" figure.

MAXIMUM RATE-OF-CLIMB DATA

GROSS WEIGHT LBS.	AT SEA LEVEL & 59° F.		AT 5000 FT. & 41° F.		AT 10000 FT. & 23° F.				
	IAS, MPH	RATE OF CLIMB FT./MIN.	IAS, MPH	RATE OF CLIMB FT./MIN.	IAS, MPH	RATE OF CLIMB FT./MIN.			
1600	76	670	0.6	73	440	1.6	70	220	3.0

NOTES: 1. Flaps retracted, full throttle, mixture leaned to smooth operation above 5000 ft.
 2. Fuel used includes warm-up and take-off allowances.
 3. For hot weather, decrease rate of climb 15 ft./min. for each 10° F above standard day temperature for particular altitude.

LANDING DISTANCE

GROSS WEIGHT LBS.	APPROACH SPEED, IAS, MPH	AT SEA LEVEL & 59° F.		AT 2500 FT. & 50° F.		AT 5000 FT. & 41° F.		AT 7500 FT. & 32° F.	
		GROUND ROLL	TOTAL TO CLEAR 50 FT. OBS	GROUND ROLL	TOTAL TO CLEAR 50 FT. OBS	GROUND ROLL	TOTAL TO CLEAR 50 FT. OBS	GROUND ROLL	TOTAL TO CLEAR 50 FT. OBS
1600	60	445	1075	470	1135	495	1195	520	1255

NOTES: 1. Decrease the distances shown by 10% for each 4 knots of headwind.
 2. Increase the distance by 10% for each 60° F. temperature increase above standard.
 3. For operation on a dry, grass runway, increase distances (both "ground roll" and "total to clear 50 ft. obstacle") by 20% of the "total to clear 50 ft. obstacle" figure.

Figure 6-3.

CRUISE PERFORMANCE

WITH LEAN MIXTURE

ALTITUDE	RPM	%BHP	TAS MPH	GAL/HR.	END. HOURS		RANGE, MILES	
					STANDARD	LONG RANGE	STANDARD	LONG RANGE
					22.5 GAL.	35 GAL.	22.5 GAL.	35 GAL.
2500	2750	92	121	7.0	3.2	5.0	390	605
	2700	87	119	6.6	3.4	5.3	410	635
	2600	77	114	5.8	3.9	6.1	445	690
	2500	68	108	5.1	4.4	6.9	475	740
	2400	60	103	4.6	4.9	7.7	505	790
	2300	53	96	4.1	5.5	8.6	535	830
	2200	46	89	3.6	6.2	9.7	550	860
	2100	40	79	3.2	7.0	10.9	555	865
	5000	2750	85	121	6.4	3.5	5.5	425
2700		80	118	6.0	3.8	5.8	445	690
2600		71	113	5.3	4.2	6.6	475	740
2500		63	107	4.8	4.7	7.4	505	790
2400		56	101	4.3	5.3	8.2	530	830
2300		49	93	3.8	5.9	9.2	550	860
2200		43	84	3.4	6.6	10.3	560	870
2100		37	71	3.0	7.5	11.7	540	835
7500		2700	74	117	5.5	4.1	6.3	480
	2600	66	111	4.9	4.6	7.1	505	790
	2500	58	105	4.4	5.1	7.9	535	830
	2400	52	98	4.0	5.7	8.8	555	860
	2300	45	89	3.6	6.3	9.8	560	875
	2200	40	77	3.2	7.1	11.1	550	850
	10,000	2700	68	116	5.1	4.4	6.8	510
2600		61	109	4.6	4.9	7.6	535	830
2500		54	102	4.1	5.4	8.5	555	865
2400		48	93	3.7	6.1	9.4	565	880
2300		42	82	3.3	6.8	10.6	555	860
12,500	2650	60	110	4.5	5.0	7.8	550	855
	2600	56	106	4.3	5.3	8.2	555	865
	2500	50	97	3.9	5.8	9.1	565	880
	2400	44	86	3.5	6.5	10.1	560	870

NOTES: 1. Maximum cruise is normally limited to 75% power.

2. In the above calculations of endurance in hours and range in miles, no allowances were made for take-off or reserve.

Figure 6-4.

MAXIMUM GLIDE

- SPEED 70 MPH (IAS)
- PROPELLER WINDMILLING
- FLAPS UP • ZERO WIND

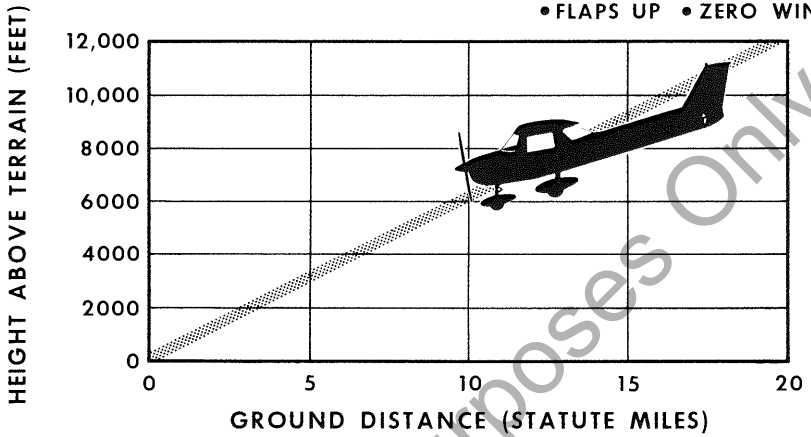

Figure 6-5.

For Training Purposes Only

For Training Purposes Only

Section VII

OPTIONAL SYSTEMS

This section contains a description, operating procedures, and performance data (when applicable) for some of the optional equipment which may be installed in your Cessna. Owner's Manual Supplements are provided to cover operation of other optional equipment systems when installed in your airplane. Contact your Cessna Dealer for a complete list of available optional equipment.

LONG RANGE FUEL TANKS

Special wings with long range fuel tanks are available to replace the standard wings and fuel tanks for greater endurance and range. Each tank has a total capacity of 19 gallons. Usable fuel in each long range tank, for all flight conditions, is 17.5 gallons.

COLD WEATHER EQUIPMENT

WINTERIZATION KIT.

For continuous operation in temperatures consistently below 20°F, the Cessna winterization kit should be installed to improve engine operation. The kit consists of two shields to partially cover the cowl nose cap opening, the addition of heat ducting from the right exhaust manifold for additional cabin heat, a carburetor airbox heat outlet cap, and insulation for the engine crankcase breather line. Once installed, the crankcase breather insulation is approved for permanent use in both cold and hot weather.

GROUND SERVICE PLUG RECEPTACLE.

A ground service plug receptacle may be installed to permit the use of an external power source for cold weather starting and during lengthy maintenance work on the electrical and electronic equipment.

Just before connecting an external power source (generator type or battery cart), the master switch should be turned "ON." This is especially important since it will enable the battery to absorb transient voltages which otherwise might damage the transistors in the electronic equipment.

The battery and external power circuits have been designed to completely eliminate the need to "jumper" across the battery contactor to close it for charging a completely "dead" battery. A special fused circuit in the external power system supplies the needed "jumper" across the contacts so that with a "dead" battery and an external power source applied, turning the master switch "ON" will close the battery contactor.

RADIO TRANSMITTER SELECTOR SWITCH

Operation of the radio equipment is normal as covered in the respective radio manuals. When the aircraft is equipped with more than one radio having transmitter capabilities, a transmitter selector switch is installed to switch the microphone to the radio unit the pilot desires to use for transmission. The switch is located in the upper left portion of the instrument panel and is labeled "TRANS, 1 and 2." Placing the switch in the upper position, labeled "1," switches the microphone to the upper transmitter; the lower position, labeled "2," switches the microphone to the lower transmitter.

BOOM MICROPHONE

A boom microphone may be mounted in the center of the cabin ceiling. Clips are provided just back of the upper edge of the windshield to stow the microphone when not in use. The boom microphone allows radio communication without the necessity of releasing any controls to handle the normal hand microphone. The microphone keying switch is a push button located on the left side of the pilot's control wheel.

WING LEVELER

A wing leveler may be installed to augment the lateral and directional stability of the airplane. The system uses the Turn Coordinator for roll and yaw sensing. Vacuum pressure, from the engine-driven vacuum pump, is routed from the Turn Coordinator to cylinder-piston servo units attached to the aileron and rudder control systems. As the airplane deviates from a wing level attitude or a given direction, vacuum pressure in the servo units is increased or relieved as needed to actuate the ailerons and rudder to oppose the deviations. The rudder action effectively corrects adverse yaw induced by the ailerons.

A separately mounted push-pull control knob, labeled "WING LVLR," is provided at the lower center of the instrument panel to turn the system on and off. A "ROLL TRIM" control knob on the Turn Coordinator is used for manual roll trim control to compensate for asymmetrical loading of fuel and passengers, and to optimize system performance in climb, cruise and let-down.

OPERATING CHECK LIST

TAKE-OFF.

- (1) "WING LVLR" Control Knob -- Check in off position (full in).

CLIMB.

- (1) Adjust elevator trim for climb.
- (2) "WING LVLR" Control Knob -- Pull control knob "ON".
- (3) "ROLL TRIM" Control Knob -- Adjust for wings level attitude.

CRUISE.

- (1) Adjust power and elevator trim for level flight.
- (2) "ROLL TRIM" Control Knob -- Adjust as desired.

DESCENT.

- (1) Adjust power and elevator trim for desired speed and rate of descent.
- (2) "ROLL TRIM" Control Knob -- Adjust as desired.

LANDING.

- (1) Before landing, push "WING LVLRL" control knob full in to the off position.

EMERGENCY PROCEDURES

If a malfunction should occur, the system is easily overpowered with pressure on the control wheel. The system should then be turned off. In the event of partial or complete vacuum failure, the wing leveler will automatically become inoperative. However, the Turn Coordinator used with the wing leveler system will not be affected by loss of vacuum since it is designed with a "back-up" system enabling it to operate from either vacuum or electrical power in the event of failure of one of these sources.

OPERATING NOTES

- (1) The wing leveler system may be overpowered at any time without damage or wear. However, for extended periods of maneuvering it may be desirable to turn the system off.
- (2) It is recommended that the system not be engaged during take-off and landing. Although the system can be easily overpowered, servo forces could significantly alter the manual "feel" of the aileron control, especially should a malfunction occur.

FUEL TANK QUICK-DRAIN VALVE KIT

Two fuel tank quick-drain valves and a fuel sampler cup are available as a kit to facilitate daily draining and inspection of fuel in the main tanks for the presence of water and sediment. The valves replace existing fuel tank drain plugs located at the lower inboard area of the wing. The fuel sampler cup, which may be stowed in the map compartment, is used to drain the valves. The sampler cup has a probe in the center of the cup. When the probe is inserted into the hole in the bottom of the drain valve and pushed upward, fuel flows into the cup to facilitate visual inspection of the fuel. As the cup is removed, the drain valve seats, stopping the flow of fuel.

OIL QUICK-DRAIN VALVE

An oil quick-drain valve is optionally offered to replace the drain plug in the oil sump drain port. The valve provides a quicker and cleaner method of draining engine oil. To drain the oil with this valve installed, slip a hose over the end of the valve, route the hose to a suitable container, then push upward on the end of the valve until it snaps into the open position. Spring clips will hold the valve open. After draining, use a screwdriver or suitable tool to snap the valve into the extended (closed) position and remove the drain hose.

TRUE AIRSPEED INDICATOR

A true airspeed indicator is available to replace the standard airspeed indicator in your airplane. The true airspeed indicator has a calibrated rotatable ring which works in conjunction with the airspeed indicator dial in a manner similar to the operation of a flight computer.

TO OBTAIN TRUE AIRSPEED, rotate ring until pressure altitude is aligned with outside air temperature in degrees Fahrenheit. Then read true airspeed on rotatable ring opposite airspeed needle.

NOTE

Pressure altitude should not be confused with indicated altitude. To obtain pressure altitude, set barometric scale on altimeter to "29.92" and read pressure altitude on altimeter. Be sure to return altimeter barometric scale to original barometric setting after pressure altitude has been obtained.

SERVICING REQUIREMENTS

FUEL:

AVIATION GRADE -- 80/87 MINIMUM GRADE
CAPACITY EACH STANDARD TANK -- 13 GALLONS
CAPACITY EACH LONG RANGE TANK -- 19 GALLONS
(DUE TO CROSS FEEDING BETWEEN FUEL TANKS, THE TANKS SHOULD BE RE-TOPPED AFTER EACH REFUELING TO ASSURE MAXIMUM CAPACITY.)

ENGINE OIL:

AVIATION GRADE -- SAE 40 ABOVE 40° F.
SAE 10W30 OR SAE 20 BELOW 40° F.
(MULTI-VISCOSITY OIL WITH A RANGE OF SAE 10W30 IS RECOMMENDED FOR IMPROVED STARTING IN COLD WEATHER. DETERGENT OR DISPERSANT OIL, CONFORMING TO CONTINENTAL MOTORS SPECIFICATION MHS-24A, MUST BE USED.)

CAPACITY OF ENGINE SUMP -- 6 QUARTS
(DO NOT OPERATE ON LESS THAN 4 QUARTS. TO MINIMIZE LOSS OF OIL THROUGH BREATHER, FILL TO 5 QUART LEVEL FOR NORMAL FLIGHTS OF LESS THAN 3 HOURS. FOR EXTENDED FLIGHT, FILL TO 6 QUARTS. IF OPTIONAL OIL FILTER IS INSTALLED, ONE ADDITIONAL QUART IS REQUIRED WHEN THE FILTER ELEMENT IS CHANGED.)

HYDRAULIC FLUID:

MIL-H-5606 HYDRAULIC FLUID

TIRE PRESSURE:

NOSE WHEEL --- 30 PSI ON 5.00 - 5, 4-PLY RATED TIRE
MAIN WHEELS -- 21 PSI ON 6.00 - 6, 4-PLY RATED TIRES

NOSE GEAR SHOCK STRUT:

KEEP FILLED WITH HYDRAULIC FLUID AND INFLATED WITH AIR TO 20 PSI. DO NOT OVER-INFLATE.



"TAKE YOUR CESSNA HOME
FOR SERVICE AT THE SIGN
OF THE CESSNA SHIELD".



CESSNA AIRCRAFT COMPANY

WICHITA, KANSAS



For Training Purposes Only